











































OUTDOOR LIGHTING  
**R** ROGER PRADIER  
Estd. 1910  
CHATEAUX • FRANCE

# Contents

	COLLECTION	PAGE	IP65
	Aubanne - 101	166	
	Avenue 2 - 102	252	
	Avenue 3 - 103	258	
	Avenue 4 - 104	264	•
	Bamboo - 105	144	•
	Bark - 191	24	•
	Belcour - 106	160	
	Bermude - 115	148	
	Boléro - 152	178	
	Boréal - 111	194	
	Brick² - 108	54	
	Carex - 192	20	•
	Chenonceau - 117	224	

	Citadelle - 116	282	•
	Cooper - 179	86	•
	Dallas - 119	182	
	Duo - 120	198	
	Equix - 121	120	•
	Faktory - 122	96	
	Grumo - 124	104	•
	Hector - 182	42	•
	Hogar - 177	32	•
	Hugy - 125	100	•
	Ibuk - 126	138	•
	Kent - 127	108	
	Kerlouan - 128	156	
	Klint - 167	62	•

	COLLECTION	PAGE	IP65
	La Hutte - 166	38	•
	LampioK 1 - 131	68	•
	LampioK 2 - 178	74	•
	LampioK 4 - 175	80	•
	Louis Philippe 1 - 134	202	
	Louis Philippe 2 - 135	206	
	Louis Philippe 7 - 136	210	
	Louis XIII - 130	276	
	Louvre - 133	218	•
	Mona - 137	116	•
	Montana - 139	152	
	Moon - 109	188	
	Newpark - 141	172	
	OL11 - 142	128	•

	OL33 - 144	132	•
	Place des Vosges 1 Évolution - 150	234	•
	Place des Vosges 1 Tradition - 151	228	
	Place des Vosges 2 - 148	240	
	Place des Vosges 3 - 149	246	
	Plémo - 190	28	•
	Ronex - 193	22	•
	RP195 - 153	92	•
	Sherlock - 154	112	•
	Square - 156	124	•
	Tetra - 162	48	•
	Victoria - 164	270	
	Vieille France - 163	214	
	Technical Specifications	288	
	Lanterns sizes		
	Motion sensors		
	Sockets		
	Commitment against light pollution		
	Compliance with PRM standards		
	Accessories		
	Ingress Protection (IP) ratings		
	Information		
	Colour chart		



# Collections

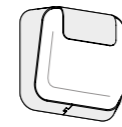

Carex  
p. 20

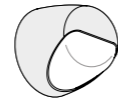

Ronex  
p. 22

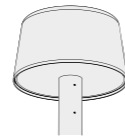

Bark  
p. 24

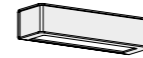

Plémo  
p. 28

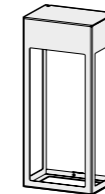

Hogar  
p. 32



La Hutte  
p. 38

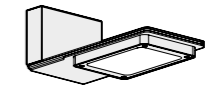

Hector  
p. 42



Tetra  
p. 48

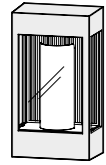

Brick²  
p. 54

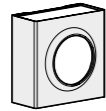

Klint  
p. 62

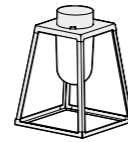

Lampiock 1  
p. 68

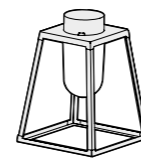

Lampiock 2  
p. 74

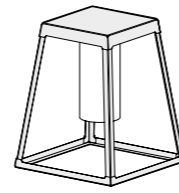

Lampiock 4  
p. 80

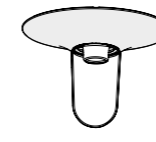

Cooper  
p. 86

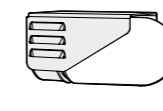

RP195  
p. 92

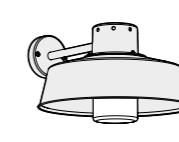

Fakory  
p. 96

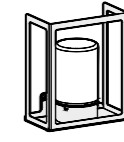

Hugy  
p. 100



Grumo  
p. 104

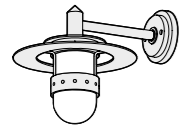

Kent  
p. 108

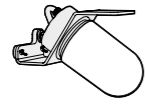

Sherlock  
p. 112



Mona  
p. 116

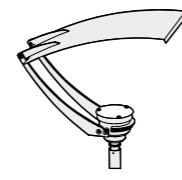

Equix  
p. 120

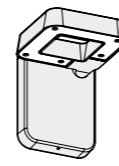

Square  
p. 124

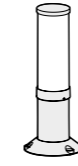

OL11  
p. 128



OL33  
p. 132

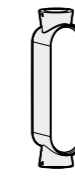

Ibuk  
p. 138

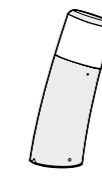

Bamboo  
p. 144

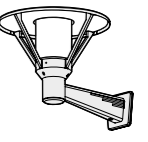

Bermude  
p. 148

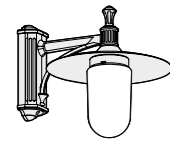

Montana  
p. 152

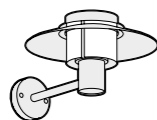

Kerlouan  
p. 156

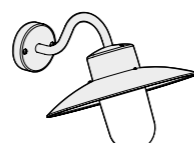

Belcour  
p. 160

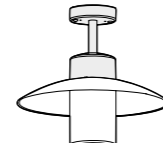

Aubanne  
p. 166

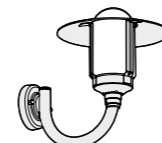

Newpark  
p. 172



Boléro  
p. 178

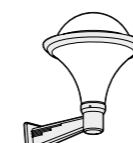

Dallas  
p. 182

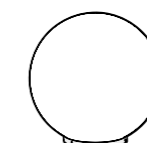

Moon  
p. 188

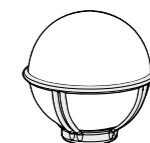

Boréal  
p. 194

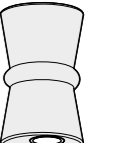

Duo  
p. 198



Louis Philippe 1  
p. 202

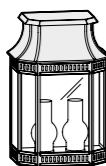

Louis Philippe 2  
p. 206



Louis Philippe 7  
p. 210



Vieille France  
p. 214



Louvre  
p. 218



Chenonceau  
p. 224



Place des Vosges 1  
Tradition  
p. 228



Place des Vosges 1  
Évolution  
p. 234



Place des Vosges 2  
p. 240



Place des Vosges 3  
p. 246

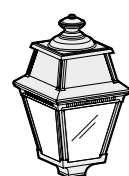

Avenue 2  
p. 252



Avenue 3  
p. 258

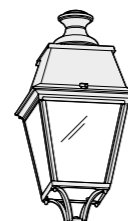

Avenue 4  
p. 264



Victoria  
p. 270



Louis XIII  
p. 276



Citadelle  
p. 282

# Editorial

---

Building on its heritage of more than 110 years, the Roger Pradier® team carries out its commitment to illuminate the outdoor spaces of our daily lives with passion.

At the start of 2024, we are proud to announce our ISO9001 certification, illustrating our dedication to quality and process management. This certification reflects our unwavering commitment and determination to offer our customers high-quality lighting fixtures and services.

As a member of the Rivalen collective, which has been “société à mission” (French legal framework in which businesses pursue a set of social and environmental purpose with specific sustainability goals) since 2022, we set out our CSR (Corporate Social Responsibility) ambitions through a GESTe action plan based on 4 main axes: Governance, Environment, Social and Territory. Focused on the reduction of our impact, this approach structures our actions, which must be respectful of the environment and the stakeholders around us. These objectives are as much new challenges to take on as they are a framework for the creation of our luminaires. With this in mind, we are carrying out research into the evolution of our materials, enabling us to offer the possibility of limiting the use of varnishes to let raw materials age and evolve. We have also partnered with our neighbour Pyrex for an unprecedented collaboration that led to the creation of 2 models, Carex & Ronex, illustrating our commitment to the circular economy.

Our attachment to the Centre Val de Loire region continues with the completion of the expansion of our plant in Châteauroux and the commissioning of our brand new zero-VOC emission powder coating line. This is an important step in our development to approach the future with serenity.

We are also taking a new step in our international development with the “UL Manufacturer” certification of our factory, which strengthens our position to expand into the North American market.

We are excited to present you our collections as well as our new creations, and to share with you, our valued partners and customers, in France and abroad, a year rich in achievements and innovations.

Jean-Michel Vergain - *General Manager*

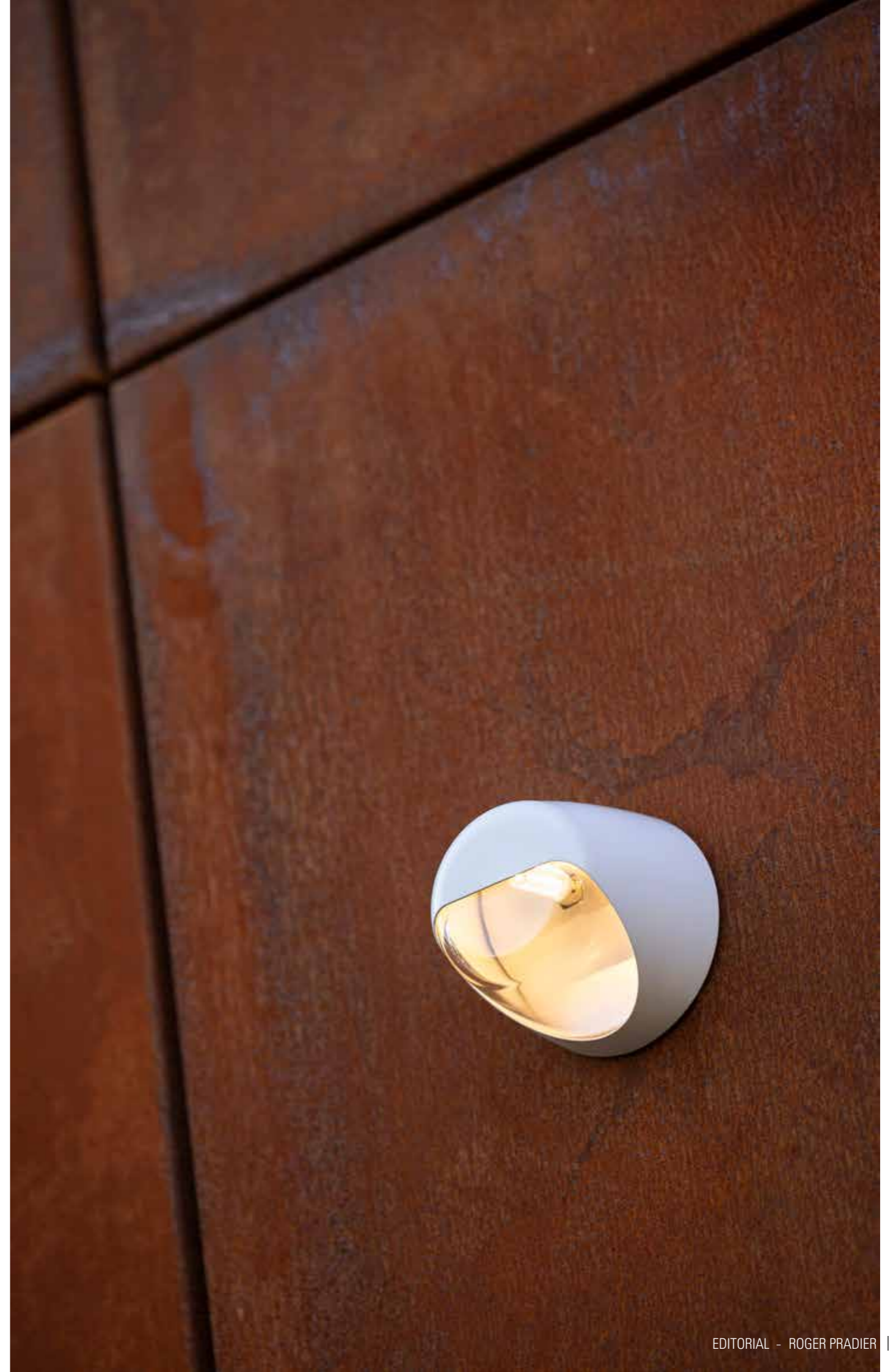



# Know-how

- 
- Research
- Creation
- Innovation
- Design
- Manufacturing
- Development
- Testing
- Tooling
- Bending
- Stamping
- Metal spinning
- Welding
- Surface treatment
- Painting
- Assembly
- Electrification assembly
- Shipping
- After-sales service
- Advice
- Tailor-made
- Lighting design

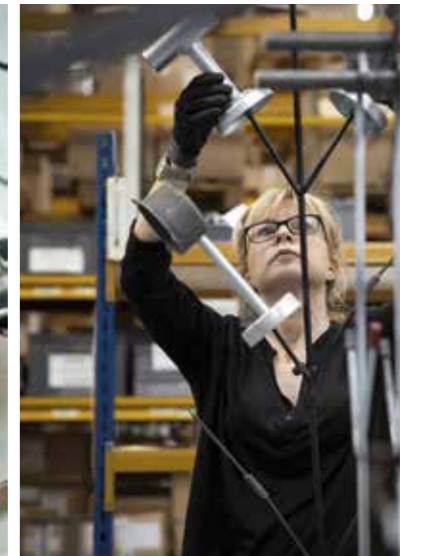



# The team



Alexandre. *Metalwork Operator*

Alexis. *Export Sales Manager*

Amandine. *Sales Assistant - France & Export*

Aurélien. *IT Manager*

Bertrand. *Industrial Designer*

Bintou. *Financial Controller*

Carole. *Assembly Operator*

Cécile. *Sales Manager - Ile-de-France Area France*

Chamouini. *Welder*

Charles. *Export Area Manager EMEA*

Christelle. *Assembly Operator*

Christine. *Surface Treatment Manager*

Christine. *Sales Manager - Southern Area France*

Christophe. *Sales Manager - Central & Southwestern Area France*

Claudie. *Assembly Operator*

Clément. *IT Technician*

Denis. *Assembly Operator*

Edith. *QHSE Manager*

Eric. *Industrial Tooling and Metalworking Manager*

Estelle. *Assembly Operator*

Fabien. *Order Picker*

Fleur. *Export Sales Assistant*

Frédéric. *Maintenance Manager*

Imanol. *Area Sales Manager - Germany*

Isabelle. *Assembly Operator*

Isabelle. *Engagement Director - Mission and CSR*

Jean-Luc. *Sales Manager - Northeastern Area France*

Jean-Michel. *General Manager*

Jérôme. *Surface Treatment Operator*

Johann. *Surface Treatment Operator*

Julie. *Assembly Operator*

Julie. *Spot Welding Machine Operator*

Julien. *Sales Manager - Rhône-Alpes Area France*

Kristell. *Administrative & Financial Director*

Laurence. *Assembly Manager*

Léa. *QHSE Assistant*

Lionel. *Forklift driver & Receiving Clerk*

Manon. *Accountant*

Marie. *Communication Manager*

Marjorie. *Assembly Operator*

Mathilde. *Sales Assistant - France*

Maud. *Sales Assistant - France*

Nathalie. *Assembly Operator*

Nathalie. *Spot Welding Machine Operator*

Patrice. *Design Production Manager*

Romain. *Financial Controller Manager*

Romain. *Industrial Development Operator*

Sabrina. *Accountant*

Salomé. *Graphic Designer*

Sébastien. *Lean Management Manager*

Sébastien. *Press Machine Operator*

Sophie. *Sales Assistant - France*

Sophie. *Plant Manager*

Stanislas. *Sales Manager - France*

Stéphane. *Creative Director*

Stéphanie. *Export Sales Assistant*

Sylvie. *Assembly Operator*

Théo. *IT Assistant*

Tristan. *CEO*

Vincent. *Sales Manager - West Area France*

Virginie. *Supplier*

Yohan. *Surface Treatment Operator*

Yvan. *Industrial Designer*



# Raw materials

Building on its mastery of noble materials and with the active collaboration of French designer François Azambourg, Roger Pradier® is committed to the ecological transition in lighting with this work on materials durability without resorting to surface treatments.

Copper and brass are characterized by their ability to age. Like fine wines, these materials improve over time by acquiring a natural patina. To inscribe this temporality in the manufacture of its lighting fixtures, Roger Pradier® now proposes them without coating. It's about not fixing their appearance and letting them, on the contrary, live and evolve to the rhythm of external elements by accepting that rain, sun and wind act and reveal another aesthetic.

This proposal for raw materials, free of any varnish, is also part of a general move to use less energy-consuming materials for the manufacture of lighting fixtures, without altering their intrinsic solidity or their operation.



Raw brass is a living material, which will evolve over time according to its environment.



Raw copper is a living material, which will evolve over time according to its environment.

This is an example of the evolution of materials over a few months, non-contractual photos.



# Roger Pradier® warranties



## 25 year anti-corrosion warranty

The Roger Pradier® company commits itself to replace any faulty part that shows sign of corrosion in a period of 25 years from the date of acquisition by the final client, upon presentation of the purchase invoice.

The guarantee applies only to the Aluminium part of Roger Pradier® products installed above ground in accordance with industry standards and with the original surface treatment intact.

Exclusions: products that are scratched, scored, covered with silicone, cement, or any other material, or that have suffered collision or various chemical treatments. This guarantee also excludes any phenomenon that may modify the aspect of the surface over time, natural dirt, deposits of all types, etc. ...

The warranty requires the product(s) to be returned to the factory. No exchange prior to that return can be considered. Roger Pradier® will only replace the damaged part and not the whole appliance; transport, dismantling and installation costs are not covered.

Roger Pradier® reserves the right to analyse or to have analysed, by any method of its choice, the damage caused by corrosion, in order to determine the reliability and the conditions of the said damage. In any event, this guarantee does not apply to the various electrical components and accessories of the product.

## 5 year technical warranty

Other than the specific 25 year anti-corrosion warranty, Roger Pradier® products are guaranteed for 5-years. The technical warranty covers over a 5-years period from the date from the acquisition date by the final client, upon presentation of the purchase receipt. This warranty shall only apply to products installed according to standard practices and which are used in conformance with our recommendations. Any intervention or modification made to the product and its components is expressly excluded from this warranty.

The warranty requires the product(s) to be returned to the factory. No exchange prior to that return can be considered. Roger Pradier® will only replace the affected component(s) and not the whole appliance; transport, dismantling and installation costs are not covered.

## Roger Pradier® commitment

- A century's worth of experience as a French manufacturer of outdoor lighting fixtures
- Widely recognized expertise
- A culture of quality
- External inspections
- International certifications. Refer to the US catalogue for UL-listed references.



# Our commitments

Being part of the **Rivalen** collective, which has been a mission-driven company since 2022, commits us to setting ambitious goals for our CSR approach, with an action plan based on **Governance, Environment, Social and Territory**.

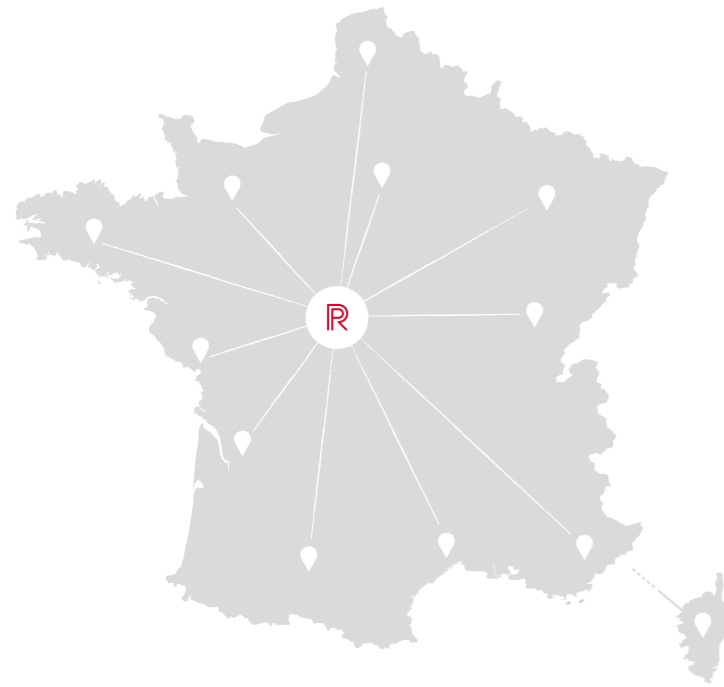

## Lighting designed and produced in Chateauroux

**110 YEARS**  
of expertise and excellence

**LOCAL**  
100% French manufacturing in our Chateauroux-based plant

**MISSION**  
Convinced that local know-how and the values of our collective of companies are strengths to sustain their performance, we design and manufacture objects which decorate or furnish living spaces by placing quality and sustainability at the heart of our industry.

**OUR VALUES**  
Audacity - Team spirit - Thoughtfulness - Humility



## Measuring and reducing our environmental footprint

**MEASURE**

- Carry out our first carbon footprint assessment in 2022
- Diagnosis of our purchasing activities in 2023, with a view to responsible purchasing action plan

**PROGRESS**

- Definition of a carbon trajectory for 2025
- Implementation of around twenty actions to reduce our energy consumption at our Châteauroux plant

**REDUCING WASTE AND PACKAGING**

- Reducing our production waste
- Reduction of production and luminaires packaging

## Deploying and leading our «GESTe» CSR approach

**PROGRESS**  
Implementation of an action plan and a progress approach with quantified objectives

**AWARENESS-RAISING AND TRAINING**

- 100% of our employees made aware of the climate and circular economy fresco
- Our purchasing, design, sales, communication, and HR departments have been trained to integrate CSR specifically into their profession

**MANAGEMENT**  
A digital tool to monitor GESTe and track the reduction of our carbon impact

**INCLUSION**

- Strengthened partnership with the ESAT (French support and work assistance establishment) in our home town
- Participation in Duo Days (where a volunteer employee welcomes a person with a disability to his or her workplace to help them discover the company and their job)

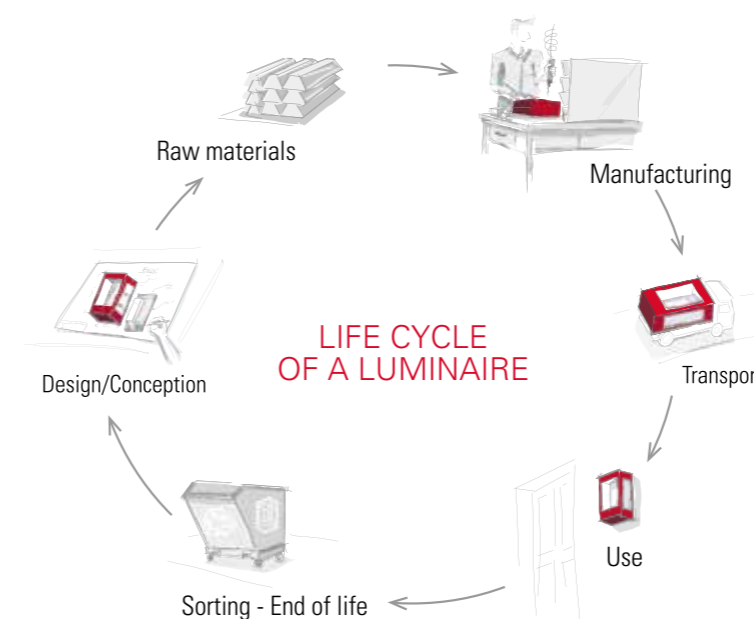

## Incorporating the circular economy into the design, manufacturing and end of life of our lighting fixtures

**ECO-DESIGN**

- Life cycle analysis (LCA) of our best seller, Brick<sup>2</sup>
- Implementation of an eco-design methodology with the aim of ensuring that any new product in the catalog is eco-designed

**MATERIALS**  
Study on the environmental impact of the materials of our lighting fixtures and on the solutions to put in place to reduce it

**SECOND LIFE OF PRODUCTS**  
Continuous progress approach on the reparability, repair and recyclability of our lighting fixtures

**INDUSTRIAL AND TERRITORIAL ECOLOGY**  
Implementation of an industrial and territorial ecology methodology at a corporate level which will be applied to Roger Pradier® (creation of incoming and outgoing flows)



# Carex & Ronex

Design Stéphane Joyeux

Since childhood and with passion, Stéphane Joyeux, Roger Pradier®'s designer, has been collecting objects and materials to imagine new creations.

The Carex & Ronex lighting fixtures draw from this art of repurposing and anchor Roger Pradier®'s environmental commitments in a logic of circular economy.

Based on the conviction that we can design and manufacture with proximity, sustainability and circularity in mind, Stéphane Joyeux imagines an encounter that seems unlikely at first glance... that of Roger Pradier® and Pyrex, a French manufacturer of household utensils with remarkable glassmaking know-how. Both companies have been based in Châteauroux since 1970. The reason for this meeting is the borosilicate glass of which Pyrex is the leader and whose quality is to resist to important thermal shocks.

Stéphane Joyeux chose two containers from Pyrex's standard production, initially intended for food preservation and cooking, and transformed them into outdoor lighting by adding a clever support sheet and a light source. The metal sheets are cut out from scrap material coming from the production of fixtures in the Roger Pradier® collection and are simply pushed back before being cut out once and then lacquered.



Pyrex® is a trademark of Corning Incorporated used under license by International Cookware





# Carex

Aluminium  
Pyrex® borosilicate glass diffuser  
IP65 / Class 2

## SOURCE

R7s LED - 10W max L78 mm - Ø25 mm max - Recommended light bulbs p.302

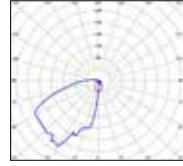

Model 1  
R7s (800 lm)  
Real light output - 354 lm

## MODEL

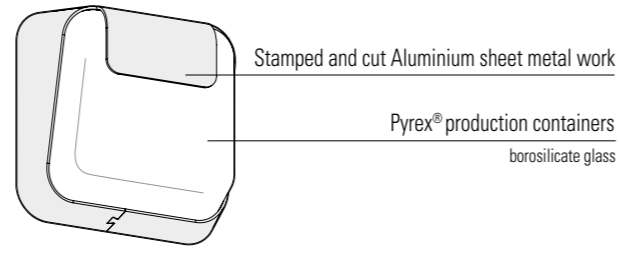

H 163 mm  
W 163 mm  
D 82 mm

## REFERENCE

Replace ●●● with the colour code

MODEL	R7s LED
1	192 001 ●●●
SPARE DIFFUSER	
	165 112 609

## COLOUR CODES

Replace ●●● with the colour code

	VELVET BLACK 113		RAL 3013 TOMATO RED 110
	RAL 7021 BLACK GREY 107		RAL 2004 PURE ORANGE 014
	WHITE 001		RAL 1016 SULFUR YELLOW 068
	RAL 9010 PURE WHITE 101		RAL 6025 FERN GREEN 109
	RAL 5011 STEEL BLUE 065		RAL 6021 PALE GREEN 133
	RAL 5009 MATTE AZURE BLUE 134		OLD RUSTIC 046
	BLUE 111		Other colours on request

## MOUNTING

Wiring entry points in grey  
Fixing kit included

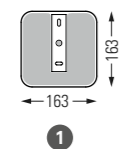

# Ronex

Aluminium  
Pyrex® borosilicate glass diffuser  
IP65 / Class 2

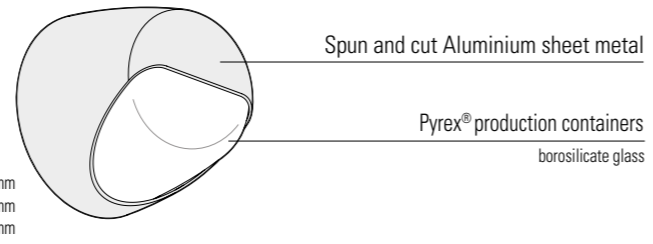

## SOURCE

G9 LED - 9W max 58 mm max - Recommended light bulbs p.302

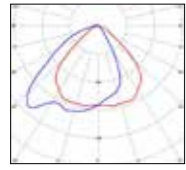

## MODEL

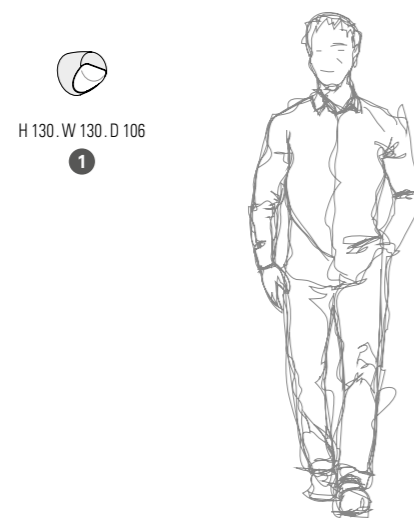

## REFERENCE

Replace ●●● with the colour code

MODEL	G9 LED
1	193 001 ●●●
	SPARE DIFFUSER
	165 113 609

## COLOUR CODES

Replace ●●● with the colour code

	VELVET BLACK 113		RAL 3013 TOMATO RED 110
	RAL 7021 BLACK GREY 107		RAL 2004 PURE ORANGE 014
	WHITE 001		RAL 1016 SULFUR YELLOW 068
	RAL 9010 PURE WHITE 101		RAL 6025 FERN GREEN 109
	RAL 5011 STEEL BLUE 065		RAL 6021 PALE GREEN 133
	RAL 5009 MATTE AZURE BLUE 134		OLD RUSTIC 046
	BLUE 111		Other colours on request

## MOUNTING

Wiring entry points in grey  
Fixing kit included

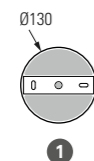



# Bark

Design Stéphane Joyeux

---



# Bark

Aluminium  
Satin-finish PMMA diffuser  
IP65 / IK07 / Class 1

## SOURCES

LED 41W - 2700K (Dimmable on request models 1 and 2)

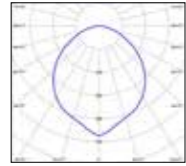

Models 1 to 3

LED 41W  
Real light output - 4500 lm  
CRI > 80

H 221 mm  
Ø 387 mm

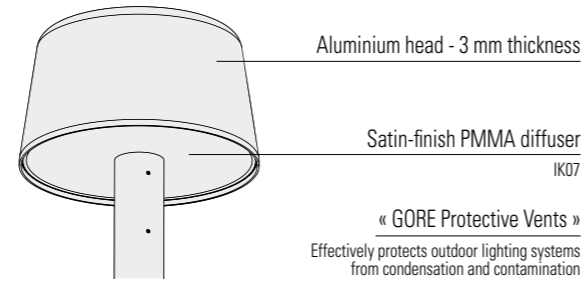

Ulor<1%

PRM Average Illuminance 20 lux p.300  
Models 1 to 3

LED 41W	Pathway	Spacing
H 2,05 m	3,00 m	24,00 m

## MODELS









## REFERENCES

Replace ●●● with the colour code

MODELS	LED 41W 2700K warm white	
1	191 001 ●●●	Dimmable on request
2	191 002 ●●●	Dimmable on request
3	191 003 ●●●(●)	

## COLOUR CODES

Replace ●●● with the colour code

 RAL 7021 BLACK GREY 107	 RAL 9010 PURE WHITE 101	 OLD RUSTIC 046
 RAL 7044 SILK GREY 105	 RAL 2004 PURE ORANGE 014	 RAL 3013 TOMATO RED 110

Other colours on request

## PLUG CODES

The standard Roger Pradier® plugs are SCHUKO plugs type F  
Except for French plugs, replace (●) with the country's plug code

 UK PLUG UK type G	 SWISS PLUG CH type J
--	---

## MOUNTING

Wiring entry points in grey  
Fixing kit included

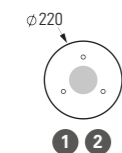

# Plémo

Design Stéphane Joyeux

---





# Plémo

Aluminium  
Frosted glass diffuser  
IP65 / Class 2

## SOURCE

G9 LED - 9W max Recommended light bulbs p.302

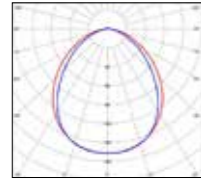

Model 1  
G9 (600 lm)  
Real light output - 192 lm

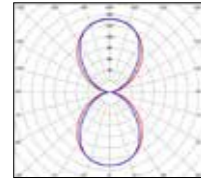

Model 2  
G9 (600 lm)  
Real light output - 378 lm

## MODELS



H 45 . W 200 . D 74  
1

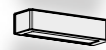

H 45 . W 200 . D 74  
2

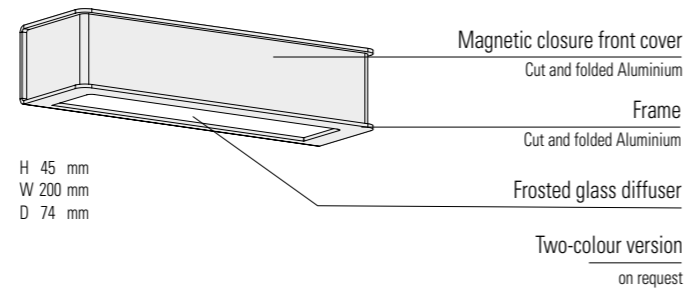

## REFERENCES

Replace **•••** with the colour code

MODELS	G9 LED
1	190 001 •••
2	190 002 •••
SPARE DIFFUSER	
	165 109 610

## COLOUR CODES

Replace **•••** with the colour code

	VELVET BLACK 113
	RAL 7021 BLACK GREY 107
	RAL 7044 SILK GREY 105
	RAL 9010 PURE WHITE 101
	RAL 5011 STEEL BLUE 065
	RAL 3005 WINE RED 066
	RAL 3013 TOMATO RED 110

	RAL 2004 PURE ORANGE 014
	RAL 6025 FERN GREEN 109
	SLATE GREY 059
	BLUE 111
	LIMESTONE 053
	SANDSTONE 054
	OLD RUSTIC 046

Other colours on request

## MOUNTING

Wiring entry points in grey  
Fixing kit included

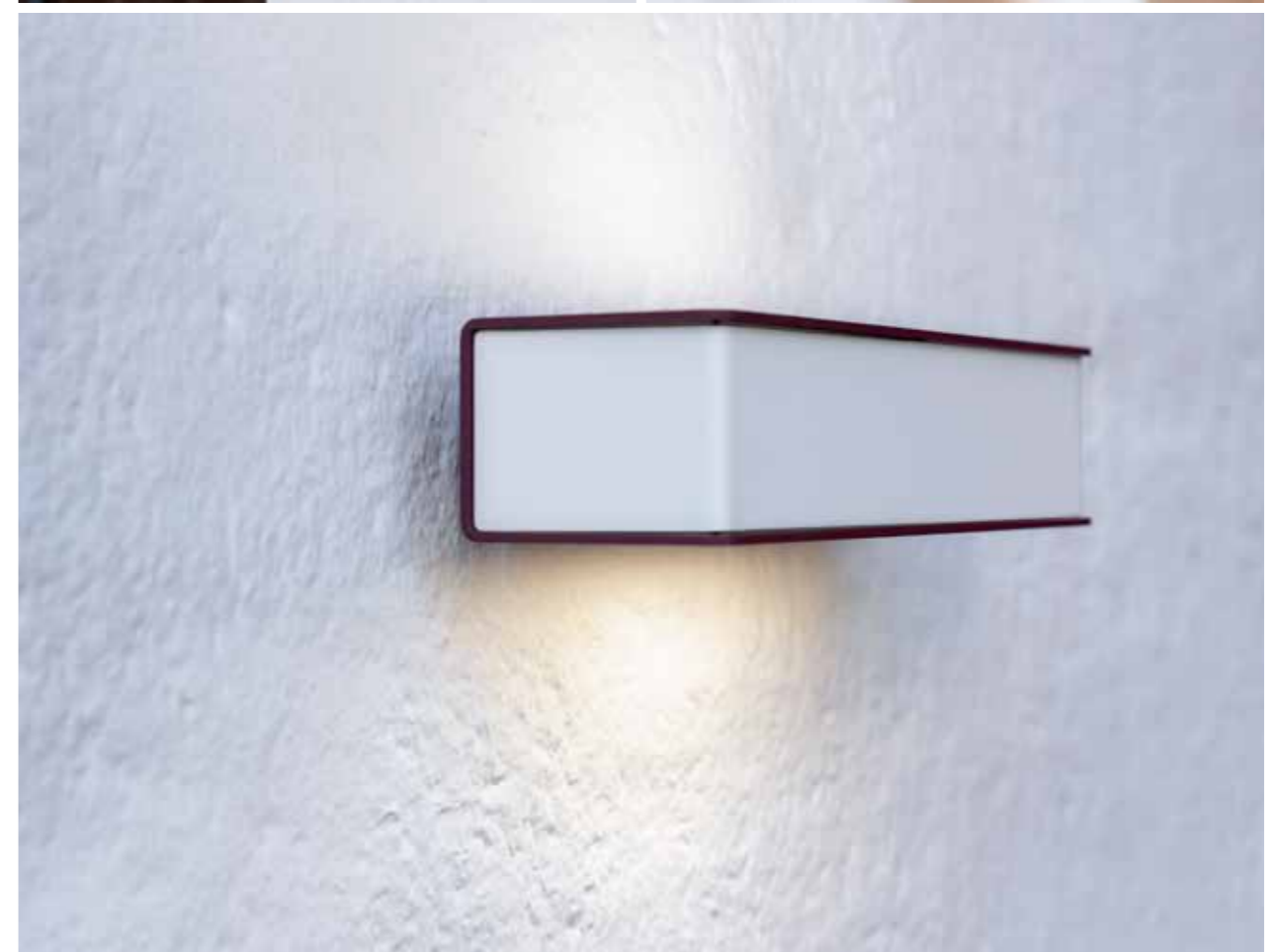
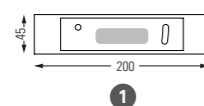



# Hogar

Design Stéphane Joyeux

---







# Hogar

Aluminium  
Satin-finish PMMA diffuser (models 1 to 4)  
IP67 (LED module and driver) / IP44 (GU10 version) / IK10  
Class 1 (models 1 to 6) - Class 2 (models 7 and 8)

## SOURCES

LED 16W - 2700K warm white (models 5 to 8) (Dimmable on request models 5 and 6)  
LED 16W - 3000K warm white (models 5 to 8) (Dimmable on request models 5 and 6)  
LED 26W - 2700K warm white  
LED 26W - 3000K warm white  
LED 35W - 1-10 Volt Dimmable - 2700K warm white  
LED 35W - 1-10 Volt Dimmable - 3000K warm white  
LED 35W - DALI Dimmable - 2700K warm white  
LED 35W - DALI Dimmable - 3000K warm white  
GU10 2x9W  
LED 26W or 35W - 4000K on request

PRM Average Illuminance 20 lux p.300  
Models 1 to 4

LED 35W	Pathway	Spacing
H 2,50 m	2,50 m	20,00 m

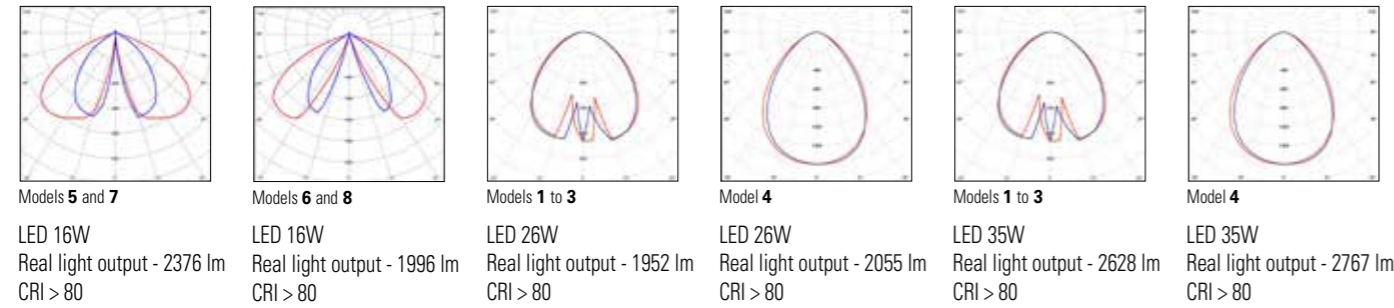
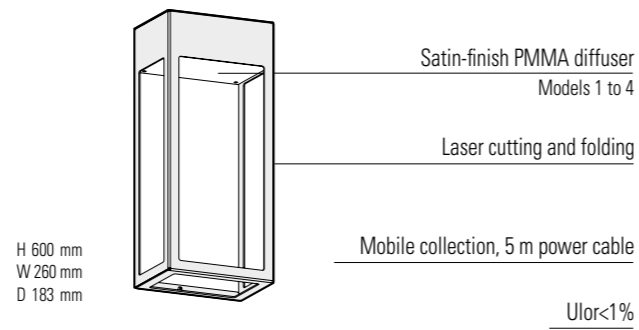

## MODELS

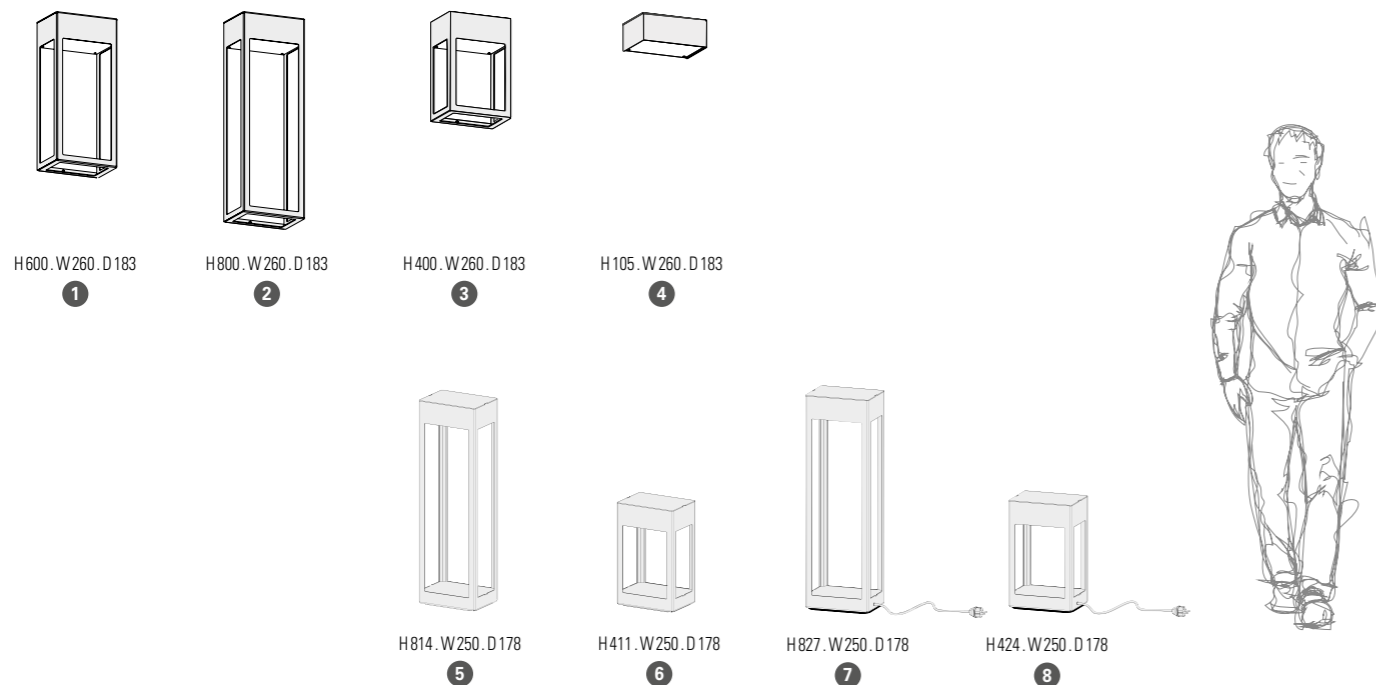

## REFERENCES

Replace ●●● with the colour code / replace (●) with the country's electrical plug code

MODELS	GU10 2x9W	LED 26W 2700K warm white	LED 26W 3000K warm white	LED 35W 2700K warm white Dimmable 1-10 Volt	LED 35W 3000K warm white Dimmable 1-10 Volt	LED 35W 2700K warm white DALI Dimmable	LED 35W 3000K warm white DALI Dimmable
1	177 058 ●●●	177 011 ●●●	177 010 ●●●	177 027 ●●●	177 026 ●●●	177 043 ●●●	177 042 ●●●
2	177 060 ●●●	177 015 ●●●	177 014 ●●●	177 031 ●●●	177 030 ●●●	177 047 ●●●	177 046 ●●●
3	177 062 ●●●	177 019 ●●●	177 018 ●●●	177 035 ●●●	177 034 ●●●	177 051 ●●●	177 050 ●●●
4	177 064 ●●●	177 023 ●●●	177 022 ●●●	177 039 ●●●	177 038 ●●●	177 055 ●●●	177 054 ●●●
SPARE DIFFUSER							
165 090 616							

MODELS	LED 16W 2700K warm white	LED 16W 3000K warm white	
5	177 069 ●●●	177 068 ●●●	Dimmable on request
6	177 067 ●●●	177 066 ●●●	Dimmable on request
7	177 073 ●●●(●)	177 072 ●●●(●)	
8	177 071 ●●●(●)	177 070 ●●●(●)	

## COLOUR CODES

Replace ●●● with the colour code

●	RAL 9005 JET BLACK	000
●	RAL 7021 BLACK GREY	107
●	RAL 7044 SILK GREY	105
●	RAL 9010 PURE WHITE	101
●	RAL 5011 STEEL BLUE	065
●	RAL 6025 FERN GREEN	109
●	RAL 6021 PALE GREEN	133
●	RAL 1016 SULFUR YELLOW	068
●	RAL 3013 TOMATO RED	110
●	OLD RUSTIC	046

Other colours on request

## PLUG CODES

The standard Roger Pradier® plugs are SCHUKO plugs type F  
Except for French plugs, replace (●) with the country's plug code

⚡	UK PLUG UK type G	SWISS PLUG CH type J
---	----------------------	-------------------------

## MOUNTING

Wiring entry points in grey  
Fixing kit included

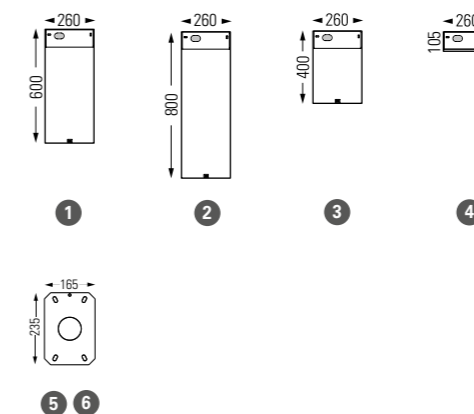

# La Hutte

Design matali crasset

---

The "La Hutte" lamp draws inspiration from the shape of a primitive hut, a circular shelter built around the fire that was essential to life.

Its protective glass casing is like the walls of a house, storing and then releasing photons. "La Hutte" is a shelter, a kindly presence that reproduces the warmth and light of a home fire.

The lamp consists of two elements: a metal base available in all colours, and a transparent blown glass diffuser. The design comes in three versions, either a table lamp, a model you can hang, or a floor lamp.





# La Hutte

Aluminium  
Clear glass diffuser  
IP65 / Class 2

## SOURCE

E27 - 23W max

## MODELS

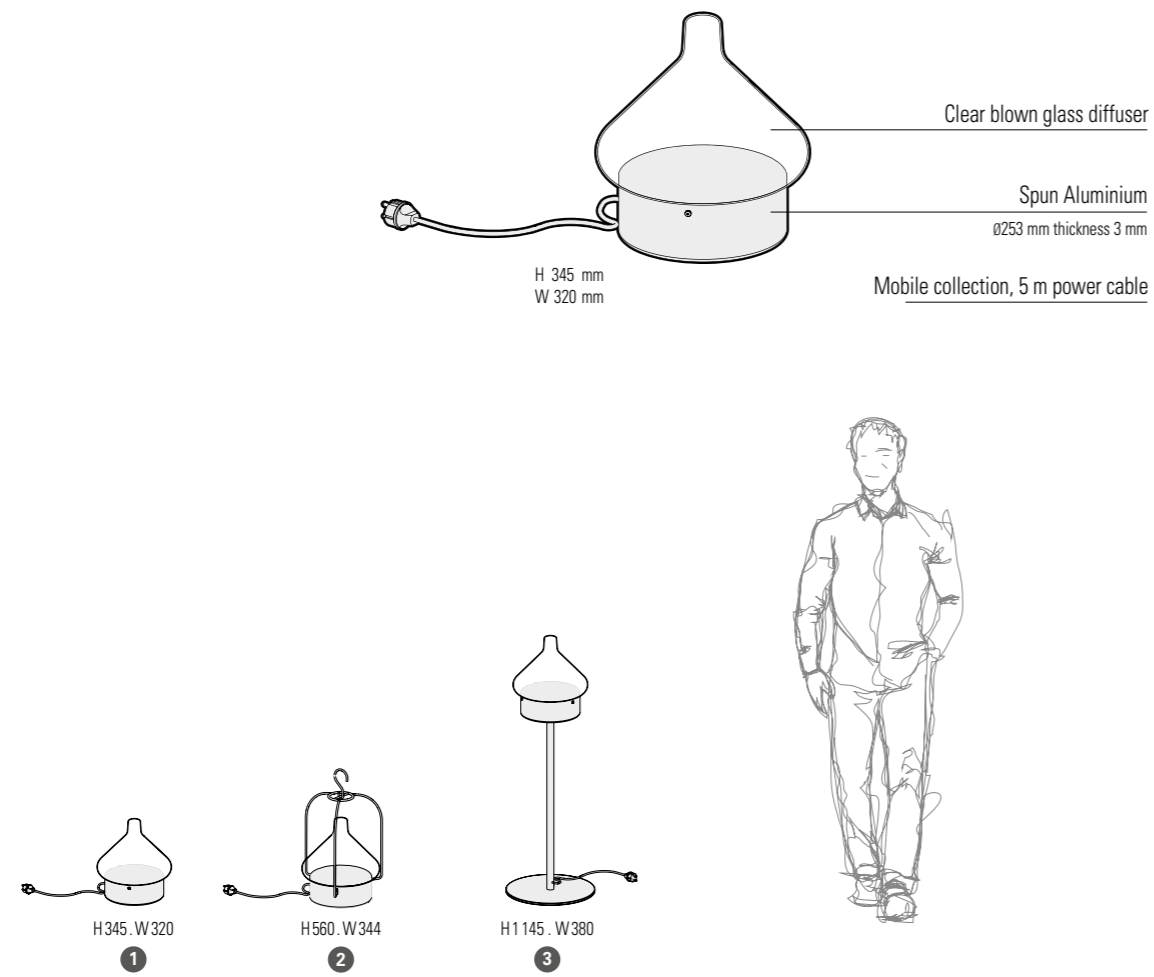

## REFERENCES

Replace **•••** with the colour code / replace **(•)** with the country's electrical plug code

MODELS	E27
1	166 001 <b>•••</b> (•)
2	166 002 <b>•••</b> (•)
3	166 003 <b>•••</b> (•)
SPARE DIFFUSER	
165 085 609	

## COLOUR CODES

Replace **•••** with the colour code ↴

	RAL 7021 BLACK GREY <b>107</b>		RAL 3005 WINE RED <b>066</b>
	RAL 9010 PURE WHITE <b>101</b>		RAL 3013 TOMATO RED <b>110</b>
	BLUE <b>111</b>		RAL 2004 PURE ORANGE <b>014</b>
Other colours on request			RAL 6025 FERN GREEN <b>109</b>

## PLUG CODES

The standard Roger Pradier® plugs are SCHUKO plugs type F  
Except for French plugs, replace **(•)** with the country's plug code ↴

	UK PLUG <b>UK</b> type G		SWISS PLUG <b>CH</b> type J
--	-----------------------------	--	--------------------------------





# Hector

Design Stéphane Joyeux

---

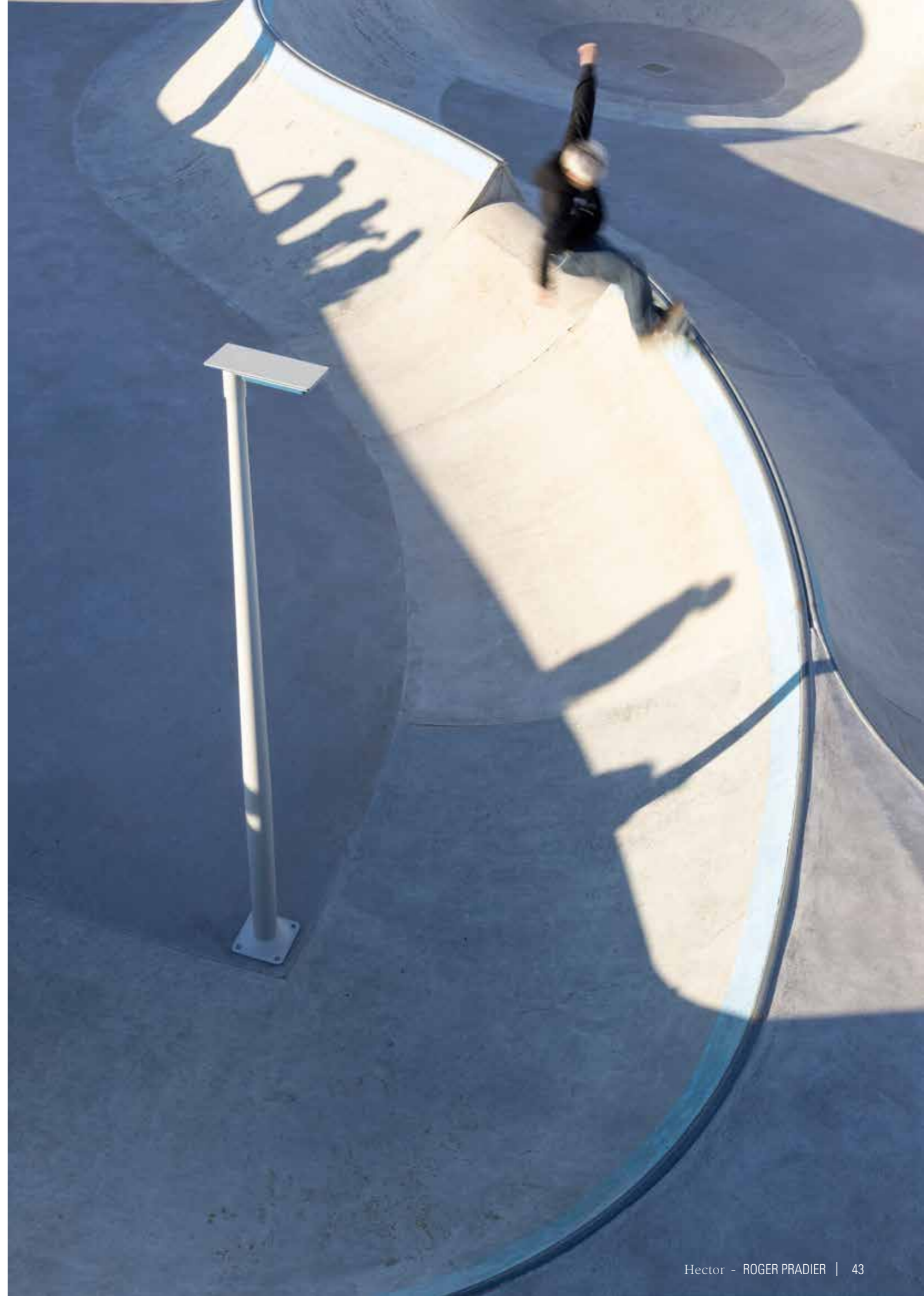







# Hector

Aluminium  
Screen-printed clear glass diffuser  
IP65 / Class 1

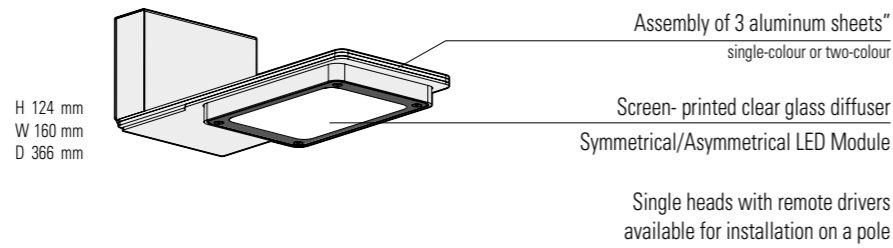

## SOURCES

LED SYM 26W - 2700K warm white / 3000K warm white  
LED ASYM 26W - 2700K warm white / 3000K warm white  
LED SYM 35W - 1-10 Volt Dimmable - 2700K warm white / Dimmable 1-10 Volt - 3000K warm white  
LED ASYM 35W - 1-10 Volt Dimmable - 2700K warm white / Dimmable 1-10 Volt - 3000K warm white  
LED SYM 35W - Dali Dimmable - 2700K warm white / Dali Dimmable - 3000K warm white  
LED ASYM 35W - Dali Dimmable - 2700K warm white / Dali Dimmable - 3000K warm white

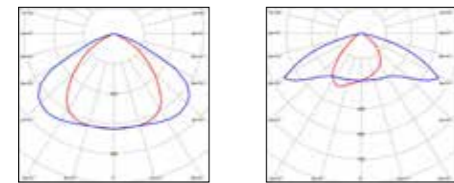

Models 1 to 3

LED 26W SYM  
Real light output - 3250 lm  
CRI > 80

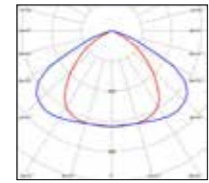

Models 1 to 3

LED 35W SYM  
Real light output - 4280 lm  
CRI > 80

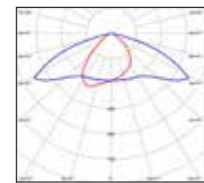

Models 1 to 3

LED 26W ASYM  
Real light output - 3270 lm  
CRI > 80

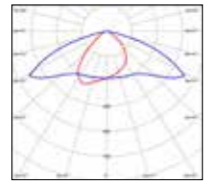

Models 1 to 3

LED 35W ASYM  
Real light output - 4250 lm  
CRI > 80

PRM Average Illuminance 20 lux p.300  
Model 2 ASYM

LED ASYM 35W	Pathway	Spacing
H 3,00m	3,00m	25,00m

## MODELS

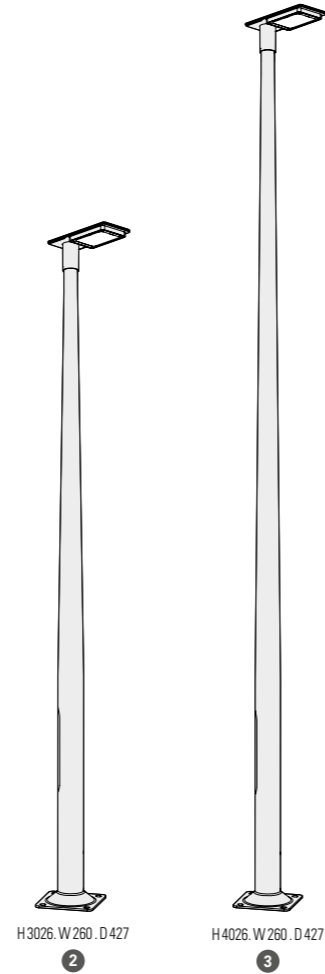

Ulor<1%

# Hector



Two-colour version  
Silk grey 105 support



Two-colour version  
Black grey 107 support

MODELS	LED SYMMETRIC			LED ASYMMETRIC		
	26W 3000K warm white	35W 3000K warm white Dimmable 1-10 Volt	35W 3000K warm white Dali Dimmable	26W 3000K warm white	35W 3000K warm white Dimmable 1-10 Volt	35W 3000K warm white Dali Dimmable
1	182 201 ●●●	182 203 ●●●	182 205 ●●●	182 202 ●●●	182 204 ●●●	182 206 ●●●
2	182 213 ●●●	182 215 ●●●	182 217 ●●●	182 214 ●●●	182 216 ●●●	182 218 ●●●
3	182 219 ●●●	182 221 ●●●	182 223 ●●●	182 220 ●●●	182 222 ●●●	182 224 ●●●

MODELS	LED SYMMETRIC			LED ASYMMETRIC		
	26W 2700K warm white	35W 2700K warm white Dimmable 1-10 Volt	35W 2700K warm white Dali Dimmable	26W 2700K warm white	35W 2700K warm white Dimmable 1-10 Volt	35W 2700K warm white Dali Dimmable
1	182 231 ●●●	182 233 ●●●	182 235 ●●●	182 232 ●●●	182 234 ●●●	182 236 ●●●
2	182 237 ●●●	182 239 ●●●	182 241 ●●●	182 238 ●●●	182 240 ●●●	182 242 ●●●
3	182 243 ●●●	182 245 ●●●	182 247 ●●●	182 244 ●●●	182 246 ●●●	182 248 ●●●

MODELS	LED SYMMETRIC			LED ASYMMETRIC		
	26W 3000K warm white	35W 3000K warm white Dimmable 1-10 Volt	35W 3000K warm white Dali Dimmable	26W 3000K warm white	35W 3000K warm white Dimmable 1-10 Volt	35W 3000K warm white Dali Dimmable
1	182 301 ●●●	182 303 ●●●	182 305 ●●●	182 302 ●●●	182 304 ●●●	182 306 ●●●
2	182 313 ●●●	182 315 ●●●	182 317 ●●●	182 314 ●●●	182 316 ●●●	182 318 ●●●
3	182 319 ●●●	182 321 ●●●	182 323 ●●●	182 320 ●●●	182 322 ●●●	182 324 ●●●

MODELS	LED SYMMETRIC			LED ASYMMETRIC		
	26W 2700K warm white	35W 2700K warm white Dimmable 1-10 Volt	35W 2700K warm white Dali Dimmable	26W 2700K warm white	35W 2700K warm white Dimmable 1-10 Volt	35W 2700K warm white Dali Dimmable
1	182 331 ●●●	182 333 ●●●	182 335 ●●●	182 332 ●●●	182 334 ●●●	182 336 ●●●
2	182 337 ●●●	182 339 ●●●	182 341 ●●●	182 338 ●●●	182 340 ●●●	182 342 ●●●
3	182 343 ●●●	182 345 ●●●	182 347 ●●●	182 344 ●●●	182 346 ●●●	182 348 ●●●

SPARE DIFFUSER

165 108 609

## COLOUR CODES

Replace ●●● with the colour code

## REFERENCES

Replace ●●● with the colour code

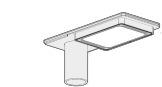

Single-colour version

MODELS	LED SYMMETRIC			LED ASYMMETRIC		
	26W 3000K warm white	35W 3000K warm white Dimmable 1-10 Volt	35W 3000K warm white Dali Dimmable	26W 3000K warm white	35W 3000K warm white Dimmable 1-10 Volt	35W 3000K warm white Dali Dimmable
1	182 001 ●●●	182 003 ●●●	182 005 ●●●	182 002 ●●●	182 004 ●●●	182 006 ●●●
2	182 013 ●●●	182 015 ●●●	182 017 ●●●	182 014 ●●●	182 016 ●●●	182 018 ●●●
3	182 019 ●●●	182 021 ●●●	182 023 ●●●	182 020 ●●●	182 022 ●●●	182 024 ●●●

MODELS	LED SYMMETRIC			LED ASYMMETRIC		
	26W 2700K warm white	35W 2700K warm white Dimmable 1-10 Volt	35W 2700K warm white Dali Dimmable	26W 2700K warm white	35W 2700K warm white Dimmable 1-10 Volt	35W 2700K warm white Dali Dimmable
1	182 031 ●●●	182 033 ●●●	182 035 ●●●	182 032 ●●●	182 034 ●●●	182 036 ●●●
2	182 037 ●●●	182 039 ●●●	182 041 ●●●	182 038 ●●●	182 040 ●●●	182 042 ●●●
3	182 043 ●●●	182 045 ●●●	182 047 ●●●	182 044 ●●●	182 046 ●●●	182 048 ●●●

Single-colour version

- 107 BLACK GREY RAL 7021
  - 105 SILK GREY RAL 7044
  - 065 STEEL BLUE RAL 5011
  - 101 PURE WHITE RAL 9010
  - 046 OLD RUSTIC
- Other colours on request

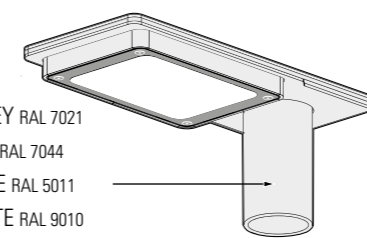

Two-colour version

- 134 MATTE AZURE BLUE RAL 5009
- 056 TRAFFIC RED RAL 3020
- 014 PURE ORANGE RAL 2004
- 068 SULFUR YELLOW RAL 1016

Other colours on request  
Specific colour (excluding Roger Pradier® colour chart) on request

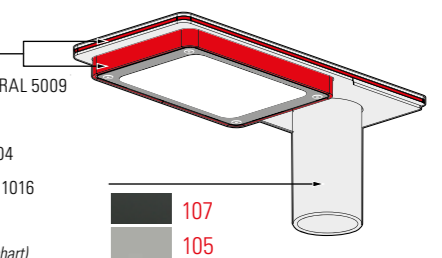

## MOUNTING

Wiring entry points in grey - Fixing kit included (model 1 only) - Anchor bolts on request (models 2 and 3) p.302



# Tetra

Design Stéphane Joyeux

---









# Tetra

Aluminium  
Clear polycarbonate diffuser  
Stainless steel bulb cover (E27 version)  
IP65 / IK10 / Class 1 / Class 3

LED (Securlite technology) - Symmetric or Asymmetric version (except models 1 and 5)  
- see p.300

## SOURCES

LED 12W - 2700K warm white  
E27 - 70W max - 230V

Ø66 mm - H175 mm max (with bulb cover)  
Ø80 mm - H180 mm max (without bulb cover)

E27 Class 3 - 8W max - 12-24V

Ø66 mm - H175 mm max (with bulb cover)  
Ø80 mm - H180 mm max (without bulb cover)

H 300 mm  
W 170 mm  
D 116 mm

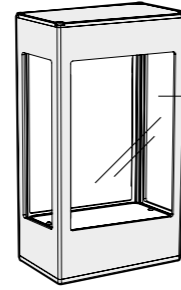

Extruded Aluminium section

Clear polycarbonate diffuser

LED version - Ulor<1%  
symmetric or asymmetric

E27 version  
with stainless steel bulb cover

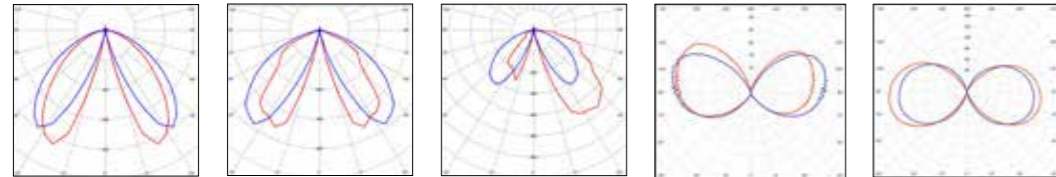

PRM Average Illuminance 20 lux p.300

Model 4 ASYM

LED 12W	Pathway	Spacing
H 1,10m	2,00m	12,00m

Models 1 and 5  
LED 12W SYM  
Real light output - 680 lm  
CRI > 80

Models 2 to 4  
LED 12W SYM  
Real light output - 797 lm  
CRI > 80

Models 2 to 4  
LED 12W ASYM  
Real light output - 879 lm  
CRI > 80

Models 1 to 5 with bulb cover  
E27 (2450 lm)

Models 1 to 5 without bulb cover  
E27 (2450 lm)

Models 1 to 5 without bulb cover  
E27 (2450 lm)

Models 1 to 5 without bulb cover  
E27 (2450 lm)

Models 1 to 5 without bulb cover  
E27 (2450 lm)

## MODELS

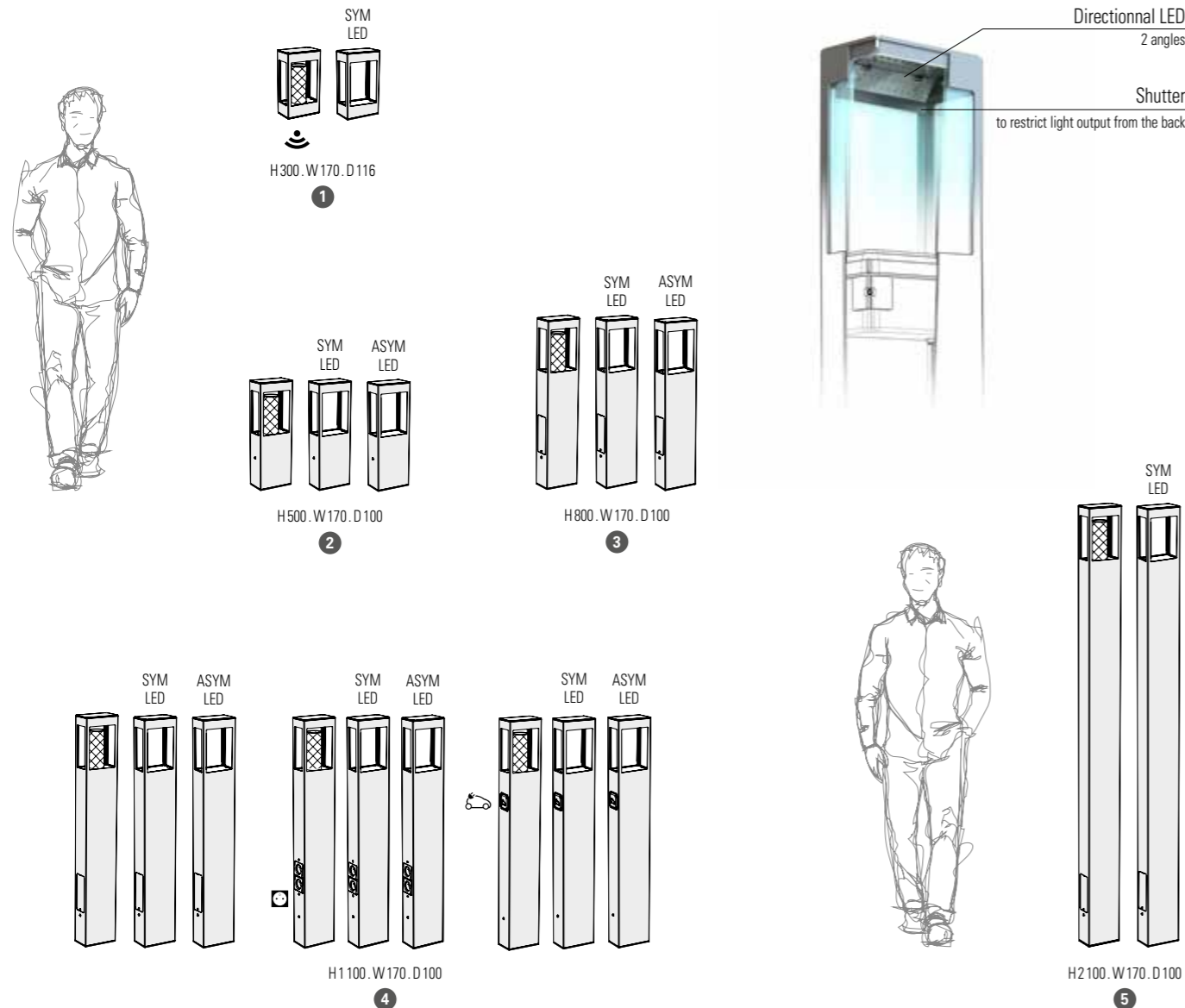

# Tetra

## REFERENCES

Replace ●●● with the colour code / replace (●) with the country's electrical socket code

MODELS	E27	E27 Class 3	LED SYMMETRIC 12W 2700K warm white	LED ASYMMETRIC 12W 2700K warm white
1	162 001 ●●●	162 036 ●●●	162 306 ●●●	
2	162 007 ●●●	162 037 ●●●	162 211 ●●●	162 111 ●●●
3	162 012 ●●●	162 038 ●●●	162 216 ●●●	162 116 ●●●
4	162 017 ●●●	162 039 ●●●	162 221 ●●●	162 121 ●●●
5	162 022 ●●●		162 326 ●●●	

☺ With sensor

MODEL	E27	E27 Class 3	LED SYMMETRIC 12W 2700K warm white	LED ASYMMETRIC 12W 2700K warm white
1	162 002 ●●●			

🔌 With sockets

MODEL	E27	E27 Class 3	LED SYMMETRIC 12W 2700K warm white	LED ASYMMETRIC 12W 2700K warm white
4	162 031 ●●●(●)		162 233 ●●●(●)	162 133 ●●●(●)

🔧 With reinforced Green'Up 16A socket  
see p.296

MODEL	E27	E27 Class 3	LED SYMMETRIC 12W 2700K warm white	LED ASYMMETRIC 12W 2700K warm white
4	162 035 ●●●		162 235 ●●●	162 135 ●●●

SPARE DIFFUSER

165 066 601

SPARE BULB COVER (E27)

165 075 018

## COLOUR CODES

Replace ●●● with the colour code

	RAL 9005 JET BLACK	000		RAL 5011 STEEL BLUE	065
	DARK GREY	006		RAL 3013 TOMATO RED	110
	METAL GREY	023		RAL 3020 TRAFFIC RED	056
	WHITE	001		OLD RUSTIC	046
	RAL 9010 PURE WHITE	101		RAL 6025 FERN GREEN	109

Other colours on request

## SOCKET CODES

Except for French socket, replace (●) with country's socket code

🔌 SCHUKO SOCKET SK type F  
🔌 SWISS SOCKET CH type J

## MOUNTING

Wiring entry points in grey  
Fixing kit included  
Anchor bolts on request (model 5) p.302

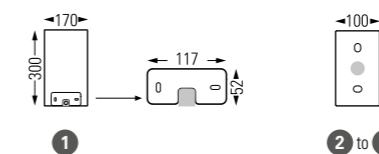

# Brick<sup>2</sup>

Design Stéphane Joyeux

---







Black anodized 144

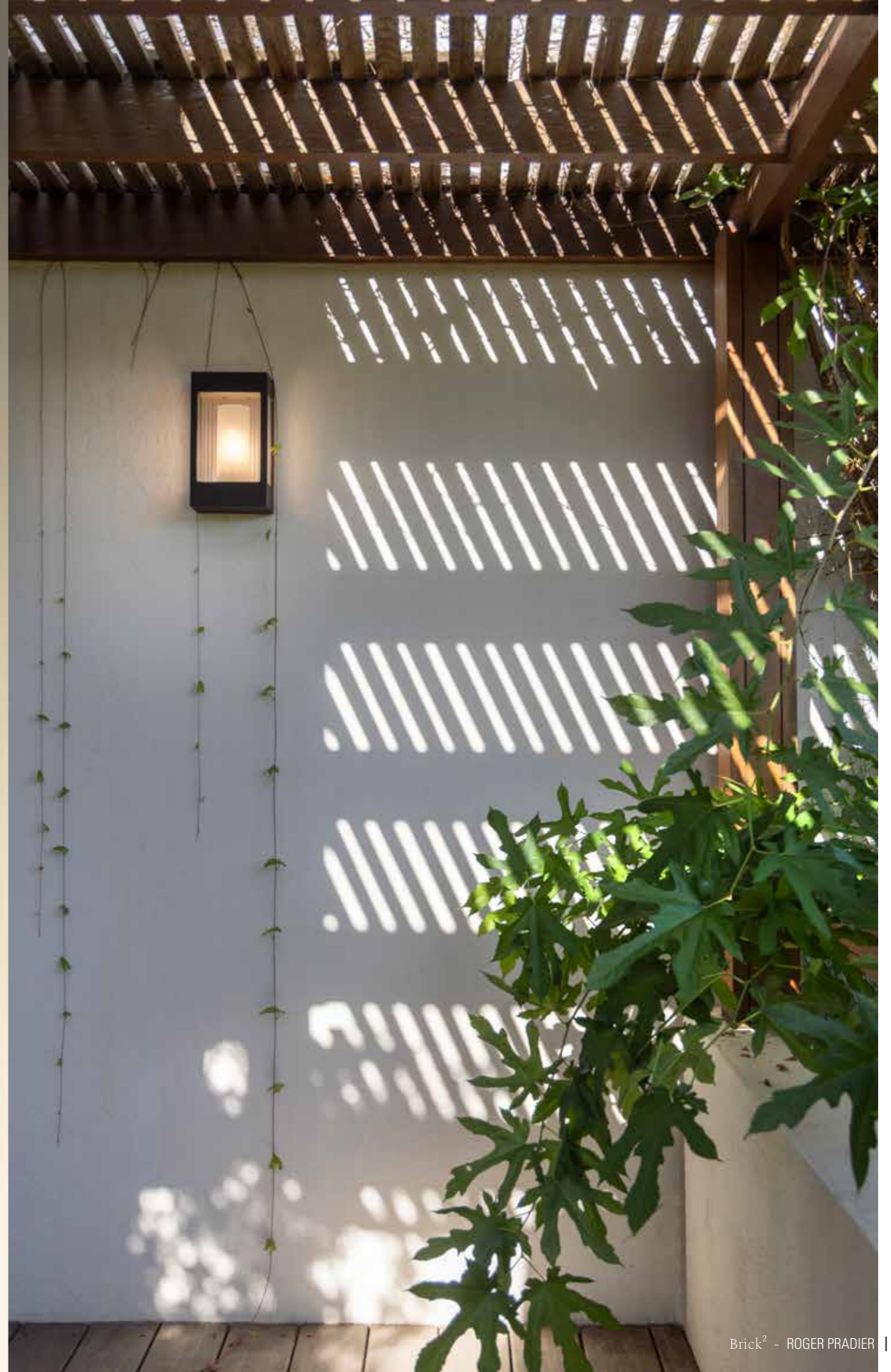







# Brick<sup>2</sup>

Aluminium  
 Clear glass or black satin-finish PMMA diffuser  
 Satin-finish polycarbonate bulb cover (model 1)  
 or Satin-finish PMMA bulb cover (models 2 to 4)  
 IP44 / Class 2 / Class 3

## SOURCES

E27 - 23W max - 230V

Ø67 mm - H175 mm max (model 1 with bulb cover)  
 Ø60 mm - H180 mm max (models 2 to 4 with bulb cover)  
 Ø80 mm - H220 mm max (models 1 to 4 without bulb cover)

E27 Class 3 - 8W max - 12-24V

Ø67 mm - H175 mm max (model 1 with bulb cover)  
 Ø60 mm - H180 mm max (models 2 to 4 with bulb cover)  
 Ø80 mm - H220 mm max (models 1 to 4 without bulb cover)

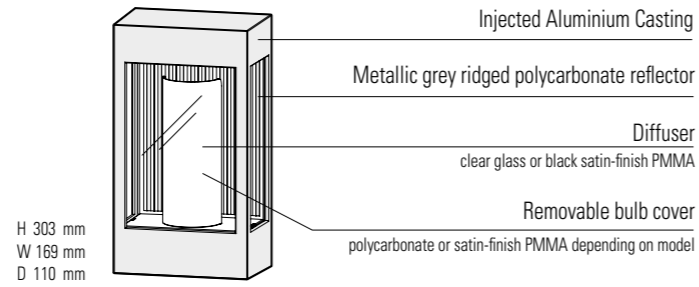

«Easycap» quick-connect system p.305

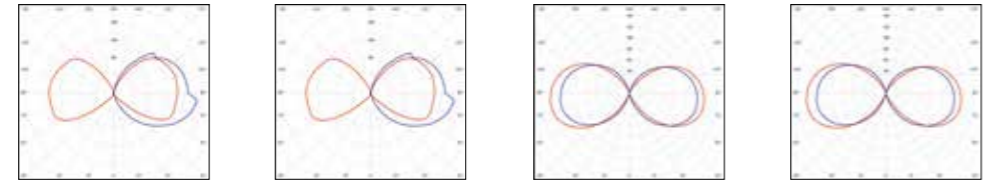

Model 1 with bulb cover E27 (2450 lm) Real light output - 1180 lm  
 Model 1 without bulb cover E27 (2450 lm) Real light output - 1671 lm  
 Models 2 to 4 with bulb cover E27 (1520 lm) Real light output - 880 lm  
 Models 2 to 4 without bulb cover E27 (2450 lm) Real light output - 2129 lm

PRM Average Illuminance 20 lux p.300  
 Model 3 without bulb cover

E27 (2450 lm)	Pathway	Spacing
H 0,80 m	2,00 m	8,00 m

## MODELS

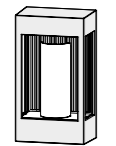

H303. W169. D110

1

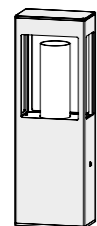

H500. W170. D100

2

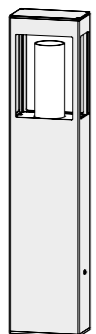

H800. W170. D100

3

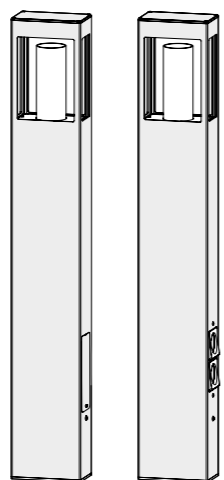

H1100. W170. D100

4



# Brick<sup>2</sup>

## REFERENCES

Replace ●●● with the colour code / replace (●) with the country's electrical socket code

MODELS	DIFFUSERS	E27	E27 Class 3	SOCKETS
1	CLEAR GLASS	108 001 ●●●	108 015 ●●●	
	BLACK PMMA	108 004 ●●●	108 016 ●●●	
2	CLEAR GLASS	108 002 ●●●	108 017 ●●●	
	BLACK PMMA	108 005 ●●●	108 018 ●●●	
3	CLEAR GLASS	108 003 ●●●	108 019 ●●●	
	BLACK PMMA	108 006 ●●●	108 020 ●●●	
4	CLEAR GLASS	108 007 ●●●	108 021 ●●●	108 009 ●●●(●)
	BLACK PMMA	108 010 ●●●	108 022 ●●●	108 012 ●●●(●)

### SPARE DIFFUSERS

CLEAR GLASS (model 1)	165 013 609
CLEAR GLASS (models 2, 3 and 4)	165 014 609
BLACK PMMA (model 1)	165 013 617
BLACK PMMA (models 2, 3 and 4)	165 014 617

### SPARE BULB COVERS

SATIN-FINISH POLYCARBONATE (model 1)	165 071 611
SATIN-FINISH PMMA (models 2, 3 and 4)	165 072 612

## COLOUR CODES

Replace ●●● with the colour code

	VELVET BLACK 113		DARK GREY 006
	RAL 7021 BLACK GREY 107		SLATE GREY 059
	RAL 7044 SILK GREY 105		WHITE 001
	RAL 9010 PURE WHITE 101		BLUE 111
	RAL 5011 STEEL BLUE 065		LIMESTONE 053
	RAL 3005 WINE RED 066		SANDSTONE 054
	RAL 3013 TOMATO RED 110		OLD RUSTIC 046
	RAL 3020 TRAFFIC RED 056		RAW ALUMINIUM - MATTE VARNISH 129 Model 1 only
	RAL 2004 PURE ORANGE 014		BLACK ANODIZED 144 Model 1 only
	RAL 6025 FERN GREEN 109		Other colours on request

## SOCKET CODES

Except for French socket, replace (●) with country's socket code

	SCHUKO SOCKET SK type F		SWISS SOCKET CH type J
--	-------------------------	--	------------------------

## MOUNTING

Wiring entry points in grey  
 Fixing kit included

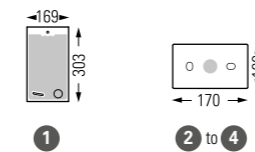

# Klint

Design Stéphane Joyeux

---





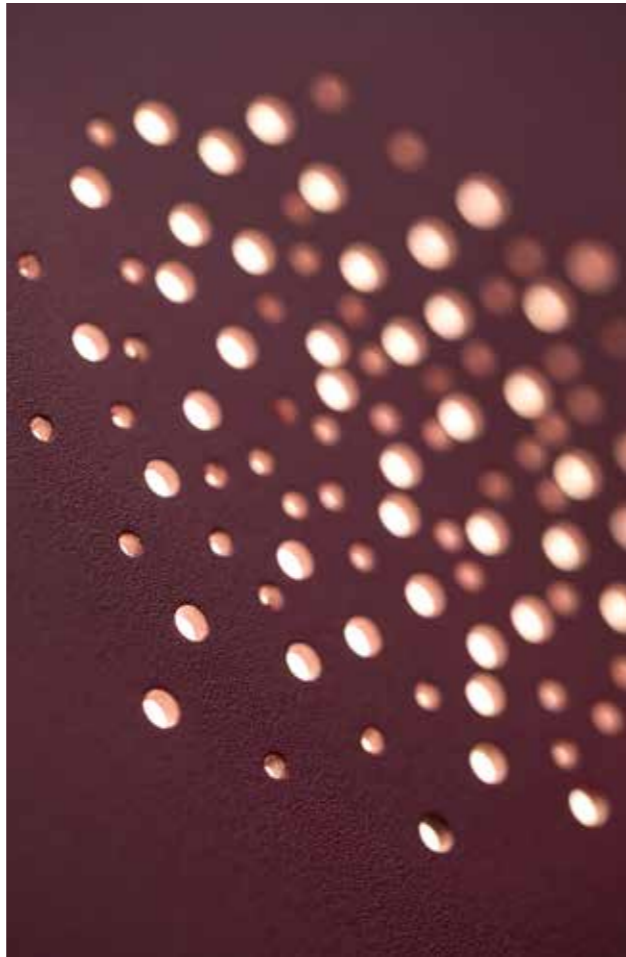

Lacquered brushed copper 084



# Klint

Aluminium - Lacquered brushed copper - Raw copper  
Clear PMMA diffuser  
IP65 / Class 2

## SOURCES

LED 2x2W - 2800K warm white  
LED 2x2W - 4000K neutral white

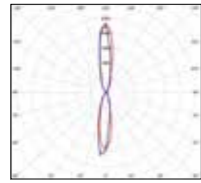

LED 2x2W - 40/40°  
Real light output - 414 lm  
CRI > 80

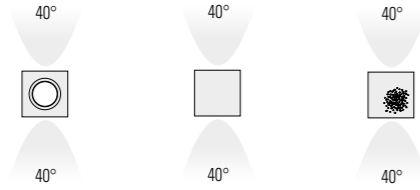

H 125 mm  
W 125 mm  
D 77 mm

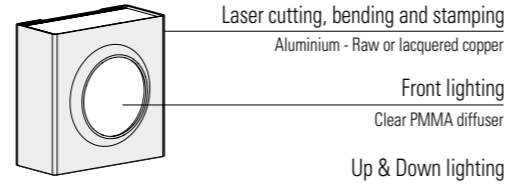

Front lighting  
Clear PMMA diffuser

Up & Down lighting

Signage  
on request

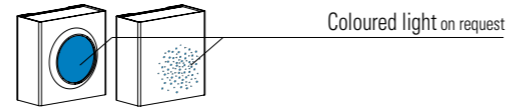

## MODELS

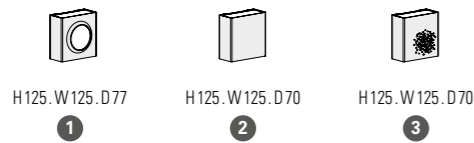

## CUSTOMIZABLE SIGNAGE

on request

In red: printing on the diffuser



- 4 Square cut out 80x80mm + printing on diffuser
- 5 Laser cutting
- 6 Laser cutting + printing on diffuser

# Klint

## REFERENCES

Replace ... with the colour code or the material code

MODELS	LED 2x2W 2800K warm white	LED 2x2W 4000K neutral white
1	167 001 ...	167 002 ...
2	167 003 ...	167 004 ...
3	167 005 ...	167 006 ...

MODELS	LED 2x2W 2800K warm white	LED 2x2W 4000K neutral white
4	167 007 ...	167 008 ...
5	167 403 ...	167 404 ...
6	167 405 ...	167 406 ...

Customizable  
signage  
on request

## COLOUR CODES

Replace ... with the colour code

VELVET BLACK	113	RAL 3005 WINE RED	066
RAL 7021 BLACK GREY	107	RAL 3020 TRAFFIC RED	056
RAL 7044 SILK GREY	105	RAL 2004 PURE ORANGE	014
RAL 9010 PURE WHITE	101	RAL 1016 SULFUR YELLOW	068
RAL 5011 STEEL BLUE	065	RAL 6009 FIR GREEN	067
BLUE	111	RAL 6025 FERN GREEN	109

Other colours on request

## MATERIAL CODES

Replace ... with the material code

LACQUERED BRUSHED COPPER	084
RAW COPPER	082 See pages 12-13

## MOUNTING

Wiring entry point in grey  
Fixing kit included

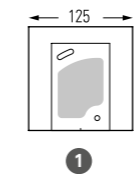



# Lampiock 1

Design Stéphane Joyeux

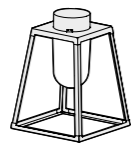

Lampiock 1

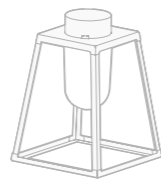

Lampiock 2

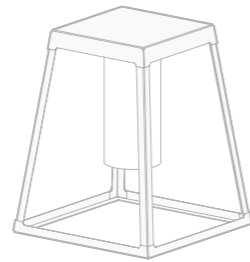

Lampiock 4







Raw copper 082

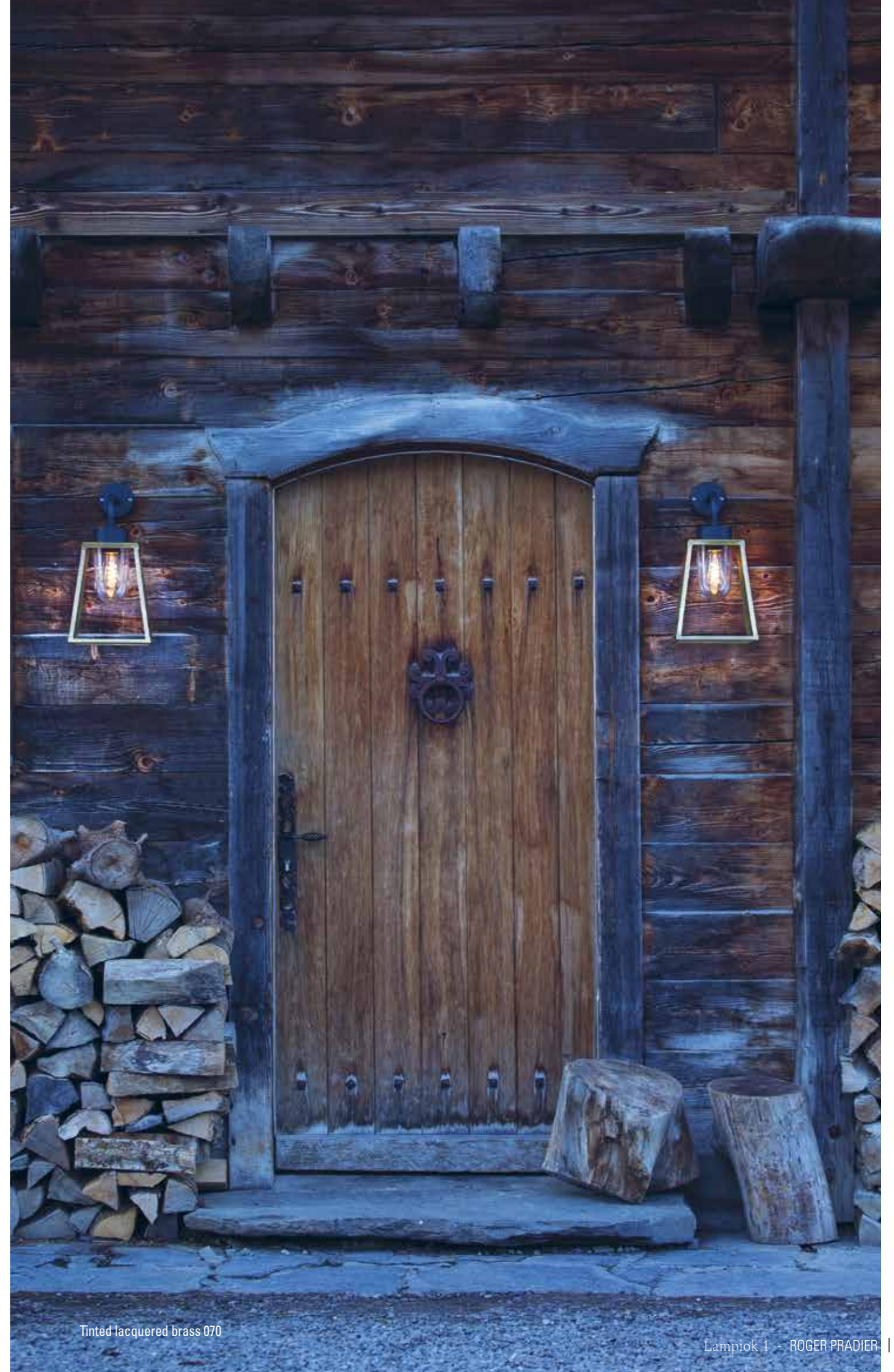

Tinted lacquered brass 070



# Lampiok 1

Aluminium - Lacquered patinated copper - Raw copper - Tinted lacquered brass - Raw brass  
 Clear or frosted glass diffuser  
 Mounting (cup, rod, bracket and pole) Black grey 107 (RAL 7021)  
 IP65 (lantern) / Class 2 / Class 1 (models 7 and 8)

## SOURCE

E27 - 52W max Ø68 mm - H150 mm max

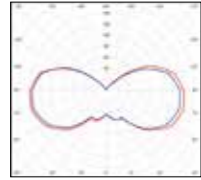

PRM Average Illuminance 20 lux p.300  
 Model 7

E27 (2450lm)	Pathway	Spacing
H 2,50m	2,00m	3,00m

E27 (2450 lm)  
 Real light output / frosted - 1558 lm  
 Real light output / clear - 1673 lm

## MODELS



H 340 . W 224

1

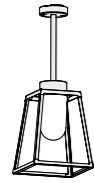

H 592 . W 224

2



H 877 . W 224

3



H 1 278 . W 224

4



H 463 . W 224 . D 403

5

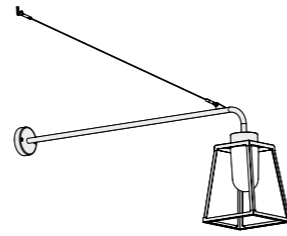

H 941 . W 224 . D 1 088

6

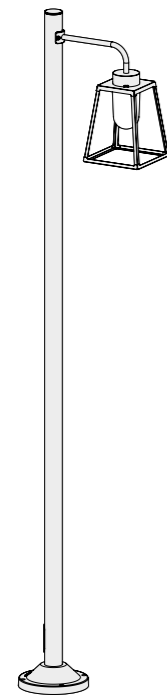

H 2 485 . W 250 . D 442

7

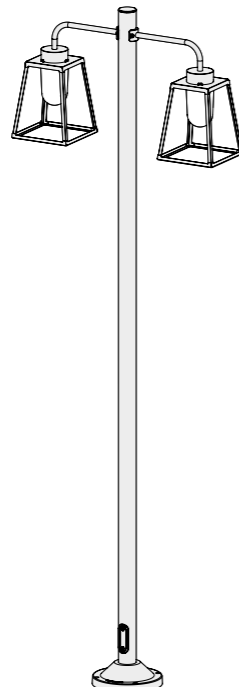

H 2 485 . W 821 . D 250

8

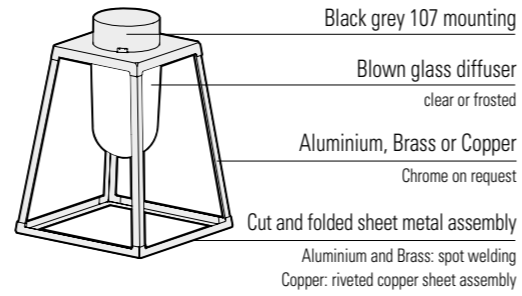

H 317 mm  
 W 224 mm

## REFERENCES

Replace ●●● with the colour code or the material code / replace (●) with the country's electrical plug code

MODELS	DIFFUSERS	E27	CORNER PLATE
1	CLEAR GLASS	131 001 ●●●(●)	
	FROSTED GLASS	131 002 ●●●(●)	
2	CLEAR GLASS	131 003 ●●●	
	FROSTED GLASS	131 004 ●●●	
3	CLEAR GLASS	131 005 ●●●	
	FROSTED GLASS	131 006 ●●●	
4	CLEAR GLASS	131 007 ●●●	
	FROSTED GLASS	131 008 ●●●	
5	CLEAR GLASS	131 009 ●●●	147 005 ●●●
	FROSTED GLASS	131 010 ●●●	
6	CLEAR GLASS	131 011 ●●●	
	FROSTED GLASS	131 012 ●●●	
7	CLEAR GLASS	131 013 ●●●	
	FROSTED GLASS	131 014 ●●●	
8	CLEAR GLASS	131 015 ●●●	
	FROSTED GLASS	131 016 ●●●	

### SPARE DIFFUSERS

CLEAR GLASS	165 035 609
FROSTED GLASS	165 035 610

## COLOUR CODES

Replace ●●● with the colour code ↴

	RAL 7021 BLACK GREY 107		RAL 3013 TOMATO RED 110
	RAL 7044 SILK GREY 105		RAL 2004 PURE ORANGE 014
	WHITE 001		RAL 1016 SULFUR YELLOW 068
	RAL 9010 PURE WHITE 101		RAL 6025 FERN GREEN 109
	BLUE 111	Other colours on request	

Support colour: Black grey 107 (RAL 7021) for all colours

## MATERIAL CODES

Replace ●●● with the material code ↴

	TINTED LACQUERED BRASS 070
	LACQUERED PATINATED COPPER 080
	RAW BRASS 072 <i>See pages 12-13</i>
	RAW COPPER 082 <i>See pages 12-13</i>

Support colour: Black grey 107 (RAL 7021) for all colours

## PLUG CODES

The standard Roger Pradier® plugs are SCHUKO plugs type F  
 Except for French plugs, replace (●) with the country's plug code ↴

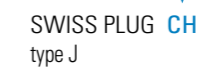

## MOUNTING

Wiring entry points in grey  
 Fixing kit included

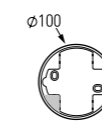

2 to 6

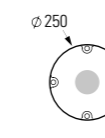

7 8

# Lampiock 2

Design Stéphane Joyeux

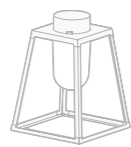

Lampiock 1

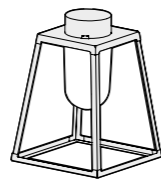

Lampiock 2

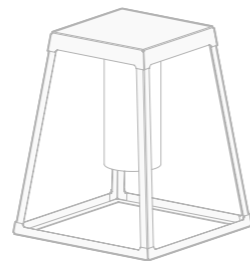

Lampiock 4







# Lampiock 2

Aluminium - Lacquered patinated copper - Raw copper - Lacquered patinated brass - Raw brass  
 Clear or frosted glass diffuser  
 Mounting (cup, rod, bracket and pole) Black grey 107 (RAL 7021)  
 IP65 (lantern) / Class 1

## SOURCE

E27 - 52W max Ø 80 mm - H 172 mm max

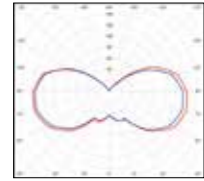

PRM Average Illuminance 20 lux p.300  
 Model 3

E27 (2450 lm)	Pathway	Spacing
H 2,50 m	2,00 m	3,00 m

E27 (2450 lm)  
 Real light output/frosted - 1558 lm  
 Real light output/clear - 1673 lm

## MODELS



H 780 . W 280

H 953 . W 280

H 547 . W 280 . D 460

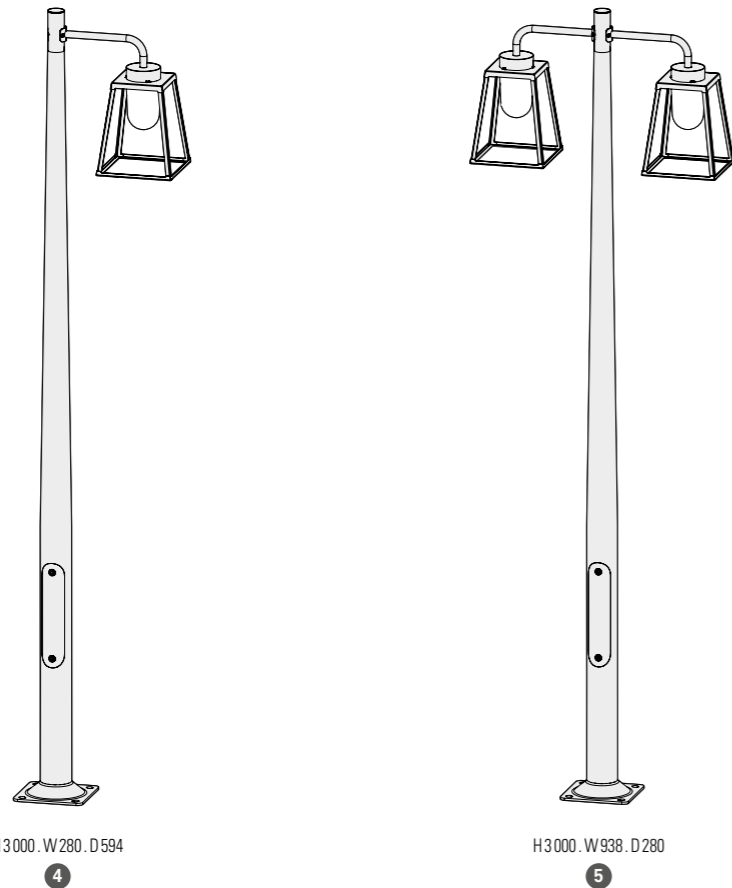

H 3000 . W 280 . D 594

H 3000 . W 938 . D 280

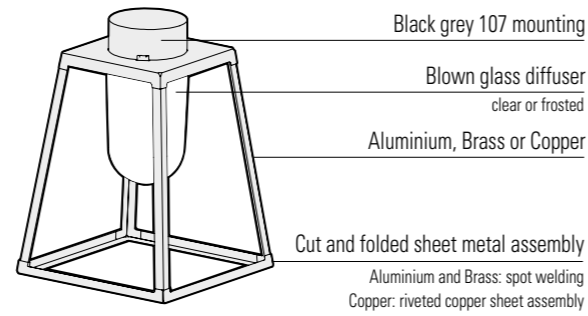

## REFERENCES

Replace ... with the colour code or the material code

MODELS	DIFFUSERS	E27	CORNER PLATE
1	CLEAR GLASS	178 001 ...	
	FROSTED GLASS	178 002 ...	
2	CLEAR GLASS	178 003 ...	
	FROSTED GLASS	178 004 ...	
3	CLEAR GLASS	178 005 ...	147 005 ...
	FROSTED GLASS	178 006 ...	
4	CLEAR GLASS	178 011 ...	
	FROSTED GLASS	178 012 ...	
5	CLEAR GLASS	178 013 ...	
	FROSTED GLASS	178 014 ...	
SPARE DIFFUSERS			
	CLEAR GLASS	165 095 609	
	FROSTED GLASS	165 095 610	

## COLOUR CODES

Replace ... with the colour code

	RAL 7021 BLACK GREY 107		RAL 3005 WINE RED 066
	RAL 7044 SILK GREY 105		RAL 3013 TOMATO RED 110
	RAL 9010 PURE WHITE 101		RAL 2004 PURE ORANGE 014
	BLUE 111		RAL 1016 SULFUR YELLOW 068
			RAL 6025 FERN GREEN 109

Other colours on request  
 Support colour: Black grey 107 (RAL 7021) for all materials

## MATERIAL CODES

Replace ... with the material code

	TINTED LACQUERED BRASS 070
	LACQUERED PATINATED COPPER 080
	RAW BRASS 072 <i>See pages 12-13</i>
	RAW COPPER 082 <i>See pages 12-13</i>

Support colour: Black grey 107 (RAL 7021) for all materials

## MOUNTING

Wiring entry points in grey  
 Fixing kit included (except models 4 and 5)  
 Anchor bolts on request (models 4 and 5) p.302

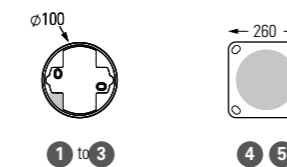



# Lampiock 4

Design Stéphane Joyeux

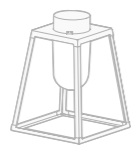

Lampiock 1

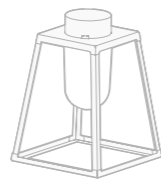

Lampiock 2

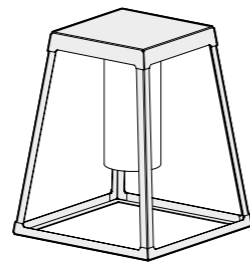

Lampiock 4







# Lampio 4

Aluminium  
 Opal or satin-finish PMMA diffuser (models 1, 3, 5)  
 Satin-finish PMMA tube diffuser (models 2, 4, 6)  
 Pole and bracket Black grey 107 (RAL 7021) for the two-colour version  
 IP65 (lantern) / Class 1

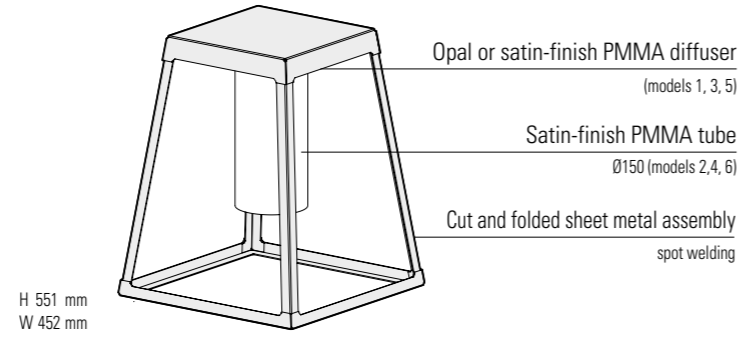

## SOURCES

LED 35W - 2700K warm white  
 LED 35W - 3000K warm white

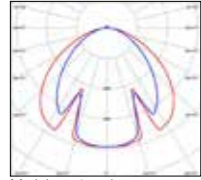

Models 1, 3 and 5

LED 35W  
 Real light output / opal - 4435 lm  
 Real light output / satin - 4794 lm  
 CRI > 80

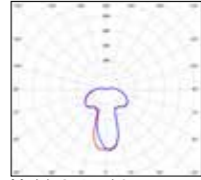

Models 2, 4 and 6

LED 35W  
 Real light output - 4903 lm  
 CRI > 80

PRM Average Illuminance 20 lux p.300  
 Model 1

LED 35W	Pathway	Spacing
H 5,00m	5,00m	16,00m

PRM Average Illuminance 20 lux p.300  
 Model 5

LED 2x35W	Pathway	Spacing
H 4,00m	5,00m	32,00m

## MODELS

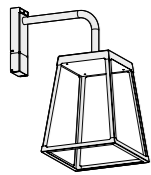

H 883 . W 452 . D 720

1

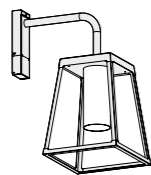

H 883 . W 452 . D 720

2

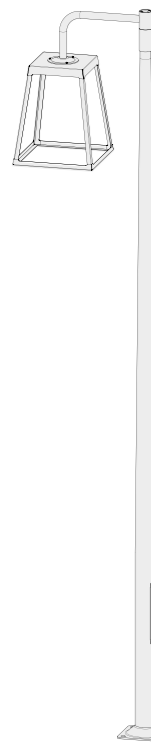

H 4070 . W 452 . D 820

3

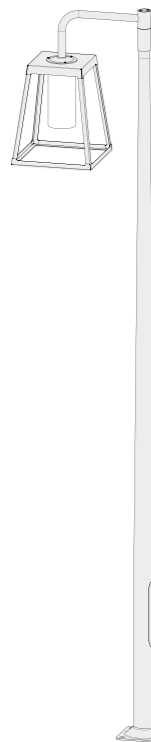

H 4070 . W 452 . D 820

4

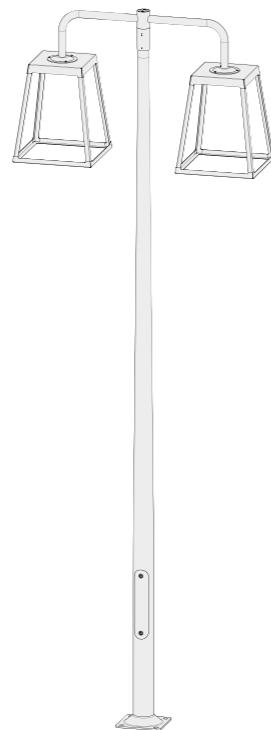

H 4070 . W 452 . D 1390

5

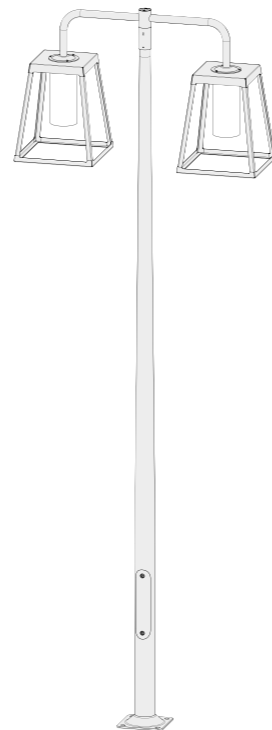

H 4070 . W 452 . D 1390

6

## REFERENCES



Single-colour version



Two-colour version  
 Black grey 107 support

Replace ●●● with the colour code

MODELS	DIFFUSERS	LED 35W 2700K warm white	LED 35W 3000K warm white
1	OPAL PMMA	175 032 ●●●	175 023 ●●●
	SATIN-FINISH PMMA	175 033 ●●●	175 024 ●●●
2	PMMA TUBE	175 034 ●●●	175 025 ●●●
3	OPAL PMMA	175 035 ●●●	175 026 ●●●
	SATIN-FINISH PMMA	175 036 ●●●	175 027 ●●●
4	PMMA TUBE	175 037 ●●●	175 028 ●●●
5	OPAL PMMA	175 038 ●●●	175 029 ●●●
	SATIN-FINISH PMMA	175 039 ●●●	175 030 ●●●
6	PMMA TUBE	175 040 ●●●	175 031 ●●●

MODELS	DIFFUSERS	LED 35W 2700K warm white	LED 35W 3000K warm white
1	OPAL PMMA	175 232 ●●●	175 223 ●●●
	SATIN-FINISH PMMA	175 233 ●●●	175 224 ●●●
2	PMMA TUBE	175 234 ●●●	175 225 ●●●
3	OPAL PMMA	175 235 ●●●	175 226 ●●●
	SATIN-FINISH PMMA	175 236 ●●●	175 227 ●●●
4	PMMA TUBE	175 237 ●●●	175 228 ●●●
5	OPAL PMMA	175 238 ●●●	175 229 ●●●
	SATIN-FINISH PMMA	175 239 ●●●	175 230 ●●●
6	PMMA TUBE	175 240 ●●●	175 231 ●●●

### SPARE DIFFUSERS

OPAL PMMA	165 091 615
SATIN-FINISH PMMA	165 091 616
PMMA TUBE	165 092 612

## COLOUR CODES

Replace ●●● with the colour code ↴



Single-colour version

●	RAL 9005 JET BLACK	000
●	RAL 7021 BLACK GREY	107
●	RAL 7044 SILK GREY	105
●	RAL 9010 PURE WHITE	101
●	RAL 6009 FIR GREEN	067
●	RAL 3013 TOMATO RED	110
●	OLD RUSTIC	046

Other colours on request



Two-colour version  
 Black grey 107 support

●	RAL 7044 SILK GREY	105
●	RAL 9010 PURE WHITE	101
●	RAL 6009 FIR GREEN	067
●	RAL 3013 TOMATO RED	110

Other colours on request

## MOUNTING

Wiring entry points in grey  
 Fixing kit included (except models 3 to 6)  
 Anchor bolts on request (models 3 to 6) p.302

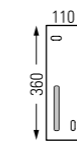

1 2

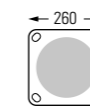

3 to 6

# Cooper

Design Stéphane Joyeux

---







Lacquered brushed brass 075



Lacquered brushed copper 084



Lacquered brushed brass 075



# Cooper

Aluminium - Lacquered brushed copper - Lacquered brushed brass - Raw copper - Raw brass  
 Black or white enamelled steel  
 Clear or frosted glass diffuser  
 Support (bracket and pole) Velvet black 113  
 IP65 / Class 2

## SOURCE

E27 - 52W max Ø68 mm - H150 mm max

## MODELS

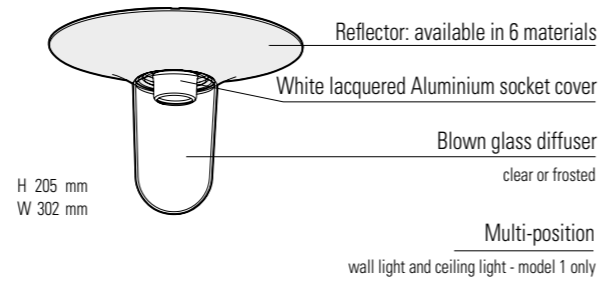

H302 . W205

1



H348 . W302 . D439

2

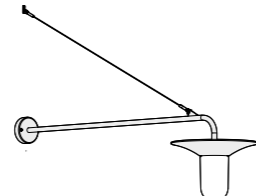

H782 . W302 . D1124

3

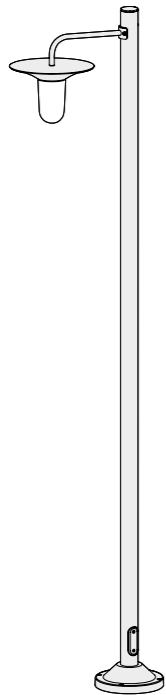

H2485 . W302 . D482

4

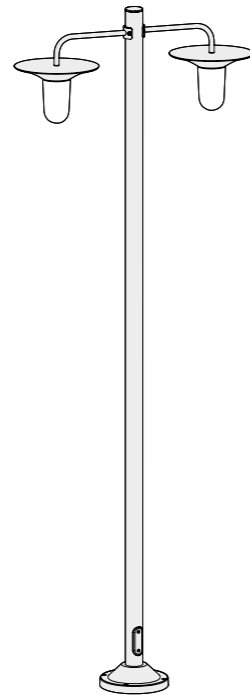

H2485 . W900 . D302

5



## REFERENCES

Replace ... with the colour code or the material code

MODELS	DIFFUSERS	E27	CORNER PLATE
1	CLEAR GLASS	179 001 ...	
	FROSTED GLASS	179 002 ...	
2	CLEAR GLASS	179 003 ...	147 005 ...
	FROSTED GLASS	179 004 ...	
3	CLEAR GLASS	179 005 ...	
	FROSTED GLASS	179 006 ...	
4	CLEAR GLASS	179 007 ...	
	FROSTED GLASS	179 008 ...	
5	CLEAR GLASS	179 009 ...	
	FROSTED GLASS	179 010 ...	
SPARE DIFFUSERS			
	CLEAR GLASS	165 035 609	
	FROSTED GLASS	165 035 610	

## COLOUR CODES

Replace ... with the colour code

	VELVET BLACK	113
	RAL 7021 BLACK GREY	107
	RAL 7044 SILK GREY	105
	RAL 9016 WHITE SIGNALISATION	114
	RAL 5009 MATTE AZURE BLUE	134
	BLUE	111
	RAL 3005 WINE RED	066
	RAL 3013 TOMATO RED	110
	RAL 2004 PURE ORANGE	014
	RAL 1016 GLOSSY SULFUR YELLOW	057
	RAL 6025 FERN GREEN	109
	OLD RUSTIC	046

Other colours on request  
 Support colour: Velvet black 113 for all colours

## MATERIAL CODES

Replace ... with the material code

	LACQUERED BRUSHED COPPER	084
	LACQUERED BRUSHED BRASS	075
	RAW COPPER	082
	RAW BRASS	072
	WHITE ENAMELLED STEEL	131
	BLACK ENAMELLED STEEL	132

See pages 12-13

See pages 12-13

Support colour: Velvet black 113 for all colours

## MOUNTING

Wiring entry points in grey  
 Fixing kit included

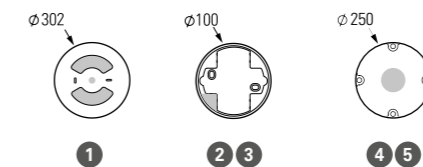



# RP195

Design Stéphane Joyeux

---





# RP195

Aluminium - Raw copper - Brushed stainless steel  
 Clear or frosted glass diffuser  
 IP65 / Class 1 (models 3 and 4) / Class 2 (models 1 and 2) / Class 3 (models 1 to 4)

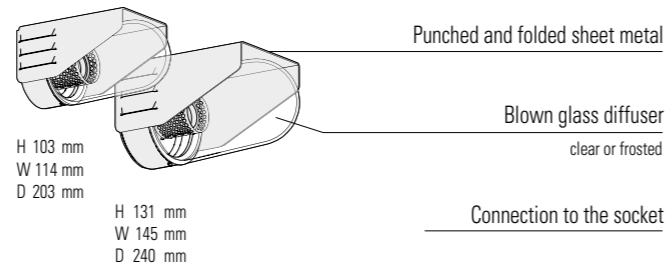

## SOURCES

E27 - 52W max - 230V (models 1 and 3) Ø68 mm - H150 mm max  
 E27 - 70W max - 230V (models 2 and 4) Ø68 mm - H150 mm max  
 E27 Class 3 - 8W max - 12-24V Ø68 mm - H150 mm max

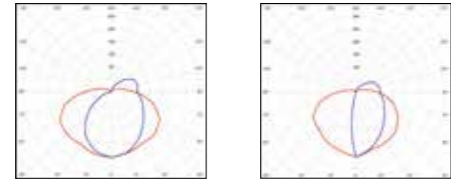

Models 1 and 3

Models 2 and 4

E27 (2450 lm) E27 (2450 lm)  
 Real light output / frosted - 1106 lm Real light output / frosted - 1024 lm  
 Real light output / clear - 1085 lm Real light output / clear - 977 lm

PRM Average Illuminance 20 lux p.300  
 Models 1 and 3

E27 (2450 lm)	Pathway	Spacing
H 2,00m	2,00m	2,50m



## MODELS

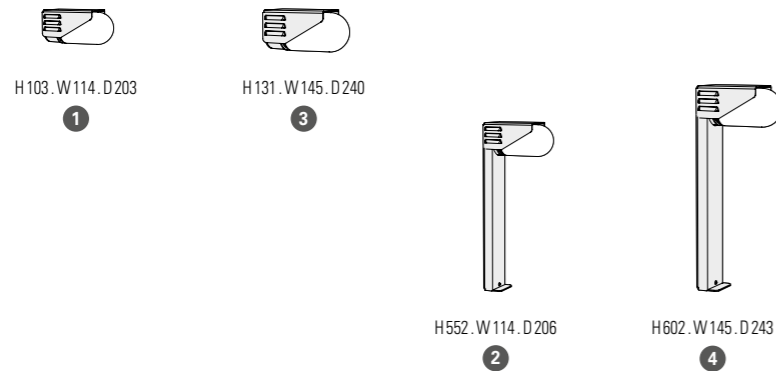

## REFERENCES

Replace ... with the colour code or the material code

MODELS	DIFFUSERS	E27	E27 Class 3
1	CLEAR GLASS	153 001 ...	153 011 ...
	FROSTED GLASS	153 002 ...	153 012 ...
2	CLEAR GLASS	153 003 ...	153 013 ...
	FROSTED GLASS	153 004 ...	153 014 ...
3	CLEAR GLASS	153 005 ...	153 015 ...
	FROSTED GLASS	153 006 ...	153 016 ...
4	CLEAR GLASS	153 007 ...	153 017 ...
	FROSTED GLASS	153 008 ...	153 018 ...

### SPARE DIFFUSERS

CLEAR GLASS (models 1 and 2)	165 035 609
FROSTED GLASS (models 1 and 2)	165 035 610
CLEAR GLASS (models 3 and 4)	165 095 609
FROSTED GLASS (models 3 and 4)	165 095 610

## MOUNTING

Wiring entry points in grey  
 Fixing kit included

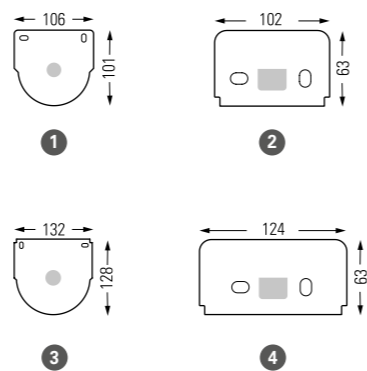

## COLOUR CODES

Replace ... with the colour code

VELVET BLACK 113	RAL 3020 TRAFFIC RED 056
DARK GREY 006	RAL 2004 PURE ORANGE 014
SLATE GREY 059	RAL 1016 SULFUR YELLOW 068
RAL 7044 SILK GREY 105	RAL 6025 FERN GREEN 109
OLD RUSTIC 046	RAL 6021 PALE GREEN 133
RAL 3005 WINE RED 066	Other colours on request

## MATERIAL CODES

Replace ... with the material code

RAW COPPER 082
See pages 12-13
STAINLESS STEEL 018
Bollard colour: Jet black 000 (RAL 9005) for raw copper





# Factory

Design Stéphane Joyeux

---





# Factory

Aluminium - Lacquered brushed copper - Raw copper - Raw zinc  
 Clear glass diffuser  
 IP44 / Class 1

## SOURCE

E27 - 70W max Ø68 mm - H 160 mm max

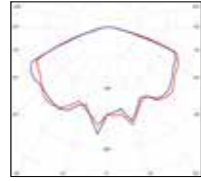

E27 (2450 lm)  
 Real light output - 1530 lm

PRM Average Illuminance 20 lux p.300  
 Model 5

E27 (2450 lm)	Pathway	Spacing
H 2,50 m	2,50 m	8,00 m

## MODELS



H223 . W346 . D438

H500 . W346

H2000 . W346

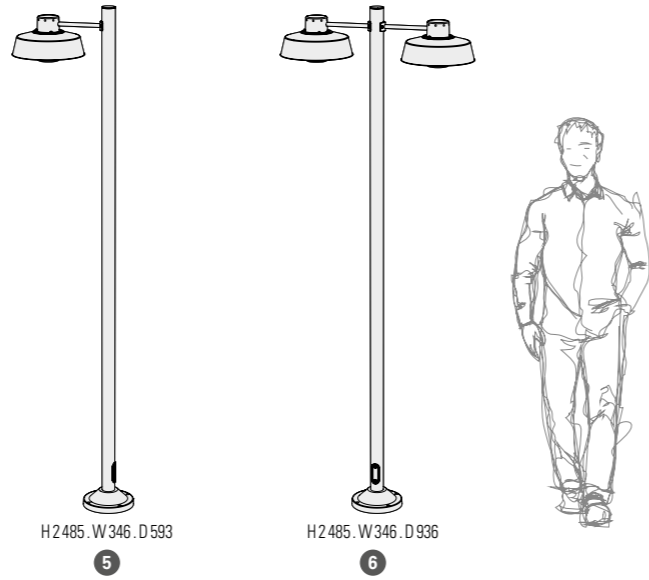

H2485 . W346 . D593

H2485 . W346 . D936

## REFERENCES

Replace ... with the colour code or the material code

MODELS	E27	CORNER PLATE
1	122 001 ...	147 005 ...
2	122 002 ...	
3	122 003 ...	
5	122 004 ...	
6	122 005 ...	
SPARE DIFFUSER		
	165 001 609	

## COLOUR CODES

Replace ... with the colour code

	RAL 7021 BLACK GREY 107		RAL 7044 SILK GREY 105		RAL 3013 TOMATO RED 110
	SLATE GREY 059		RAL 9010 PURE WHITE 101		OLD RUSTIC 046

Other colours on request

## MATERIAL CODES

Replace ... with the material code

	LACQUERED BRUSHED COPPER 084
	RAW COPPER 082 <i>See pages 12-13</i>
	RAW ZINC 092 <i>See pages 12-13</i>

Support colour: Jet black 000 (RAL 9005) for all materials

## MOUNTING

Wiring entry points in grey  
 Fixing kit included

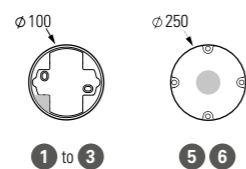

1 to 3

5 6

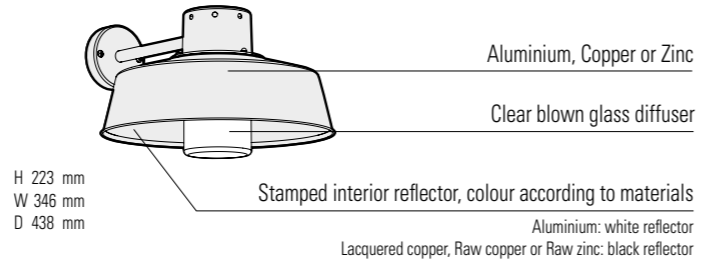



# Hugy

Design Stéphane Joyeux

---





# Hugy

Aluminium  
Clear or frosted glass diffuser  
IP65 / Class 2

## SOURCE

E27 - 42W max    Ø68 mm - H130 mm max

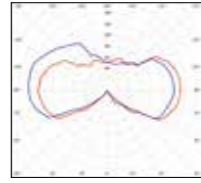

E27 (2450 lm)  
Real light output / frosted - 2286 lm  
Real light output / clear - 1939 lm

## MODEL

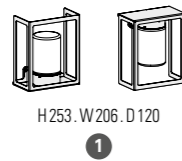

H 253. W 206. D 120

1

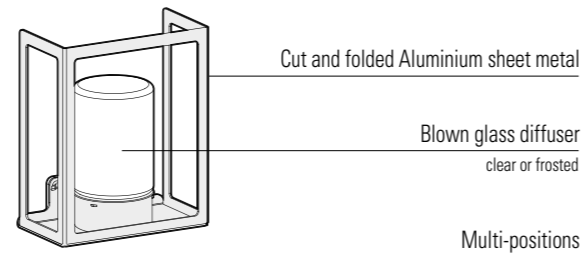

H 253 mm  
W 206 mm  
D 120 mm

Cut and folded Aluminium sheet metal

Blown glass diffuser  
clear or frosted

Multi-positions  
wall light and ceiling light











## REFERENCES

Replace ●●● with the colour code

MODEL	DIFFUSERS	E27
1	CLEAR GLASS	125 001 ●●●
	FROSTED GLASS	125 002 ●●●
SPARE DIFFUSERS		
	CLEAR GLASS	165 001 609
	FROSTED GLASS	165 001 610

## COLOUR CODES

Replace ●●● with the colour code

	RAL 7021 BLACK GREY 107		OLD RUSTIC 046
	DARK GREY 006		RAL 3020 TRAFFIC RED 056
	SLATE GREY 059		RAL 2004 PURE ORANGE 014
	RAL 7044 SILK GREY 105		RAL 6025 FERN GREEN 109
	RAL 9010 PURE WHITE 101		RAL 1016 SULFUR YELLOW 068

Other colours on request

## MOUNTING

Wiring entry point in grey  
Fixing kit included

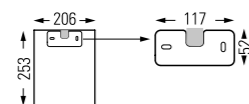

1





# Grumo

Design Stéphane Joyeux

---



# Grumo

Aluminium  
Opal polycarbonate diffuser  
IP65 / IK09 / Class 1

## SOURCE

E27 - 52W max Ø 120 mm - H 280 mm max

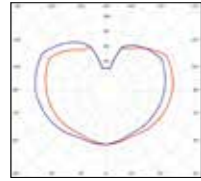

E27 (2450 lm)  
Real light output - 1572 lm

## MODELS

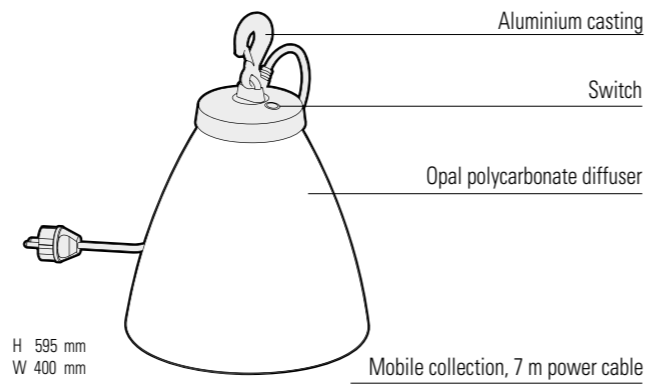
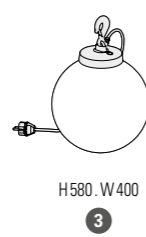
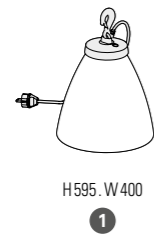

## REFERENCES

Replace ●●● with the colour code / replace (●) with the country's electrical plug code

MODELS	E27	SPARE DIFFUSERS
<b>1</b>	124 001 ●●● (●)	165 027 602
<b>3</b>	124 002 ●●● (●)	165 028 602

## COLOUR CODES

Replace ●●● with the colour code ↴

	RAL 7021 BLACK GREY 107		RAL 3020 TRAFFIC RED 056
	RAL 7044 SILK GREY 105		RAL 2004 PURE ORANGE 014
	RAL 5011 STEEL BLUE 065		RAL 6018 YELLOW GREEN 015
Other colours on request			RAL 6021 PALE GREEN 133

## PLUG CODES

The standard Roger Pradier® plugs are SCHUKO plugs type F  
Except for French plugs, replace (●) with the country's plug code ↴

	UK PLUG <b>UK</b> type G		SWISS PLUG <b>CH</b> type J
--	-----------------------------	--	--------------------------------





Kent

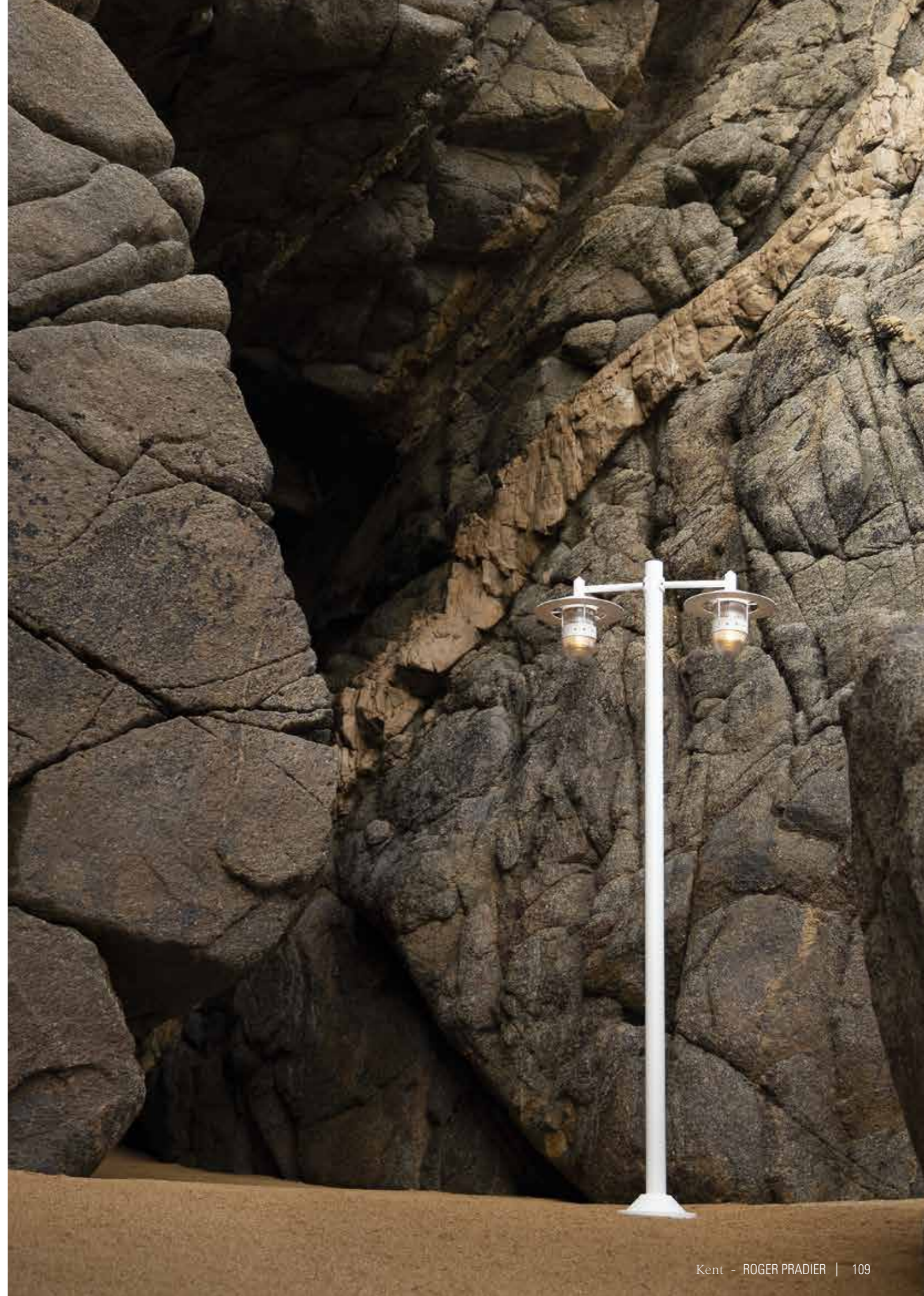



# Kent

Aluminium  
Prismatic clear glass diffuser  
IP44 / Class 1

## SOURCE

E27 - 105W max Ø80 mm - H140 mm max

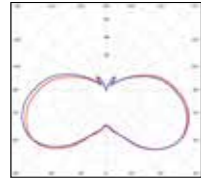

E27 (2450 lm)  
Real light output - 2055 lm

PRM Average Illuminance 20 lux p.300  
Model 4

E27 (2450 lm)	Pathway	Spacing
H 2,20m	2,50m	3,50m

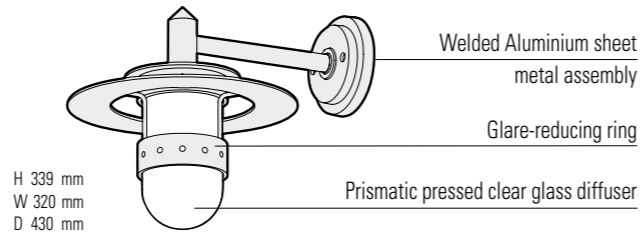

## MODELS



H330 . W320

1

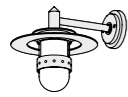

H339 . W320 . D 430

2

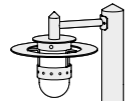

H 1001 . W320 . D 517

3

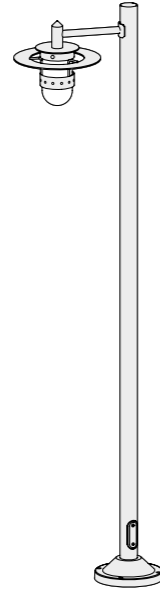

H2 185 . W320 . D 559

4

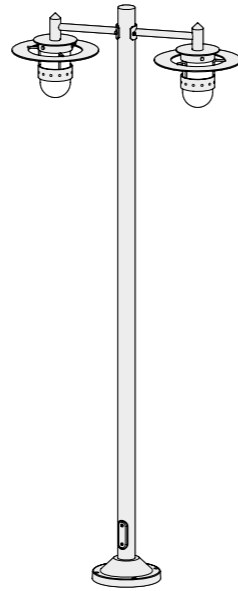

H2 185 . W320 . D 869

5



## REFERENCES

Replace ●●● with the colour code

MODELS	E27
1	CLEAR GLASS 127 006 ●●●
	FROSTED GLASS 127 007 ●●●
2	CLEAR GLASS 127 008 ●●●
	FROSTED GLASS 127 009 ●●●
3	CLEAR GLASS 127 010 ●●●
	FROSTED GLASS 127 011 ●●●
4	CLEAR GLASS 127 012 ●●●
	FROSTED GLASS 127 013 ●●●
5	CLEAR GLASS 127 014 ●●●
	FROSTED GLASS 127 015 ●●●
SPARE DIFFUSER	
	CLEAR GLASS 165 111 609
	FROSTED GLASS 165 111 610

## COLOUR CODES

Replace ●●● with the colour code

■	RAL 7021 BLACK GREY 107	■	RAL 5011 STEEL BLUE 065
■	DARK GREY 006	■	BLUE 111
■	SLATE GREY 059	■	OLD RUSTIC 046
■	RAL 7044 SILK GREY 105	■	RAL 6025 FERN GREEN 109
■	RAL 9010 PURE WHITE 101	■	RAL 6009 FIR GREEN 067
■	RAL 3013 TOMATO RED 110	Other colours on request	

## MOUNTING

Wiring entry points in grey  
Fixing kit included

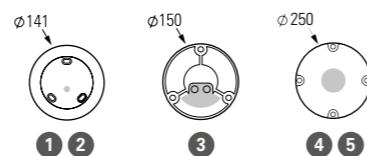



# Sherlock

Design Stéphane Joyeux

---





# Sherlock

Aluminium  
Clear or frosted glass diffuser  
IP65 / Class 1 (models 3 and 4) / Class 2 (models 1 and 2) / Class 3 (models 1 to 4)

## SOURCES

E27 - 42W max - 230V Ø68 mm - H150 mm max  
E27 Class 3 - 8W max - 12-24V Ø68 mm - H150 mm max

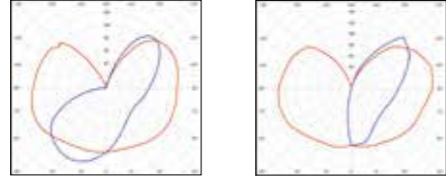

Models 1 and 3  
E27 (2450 lm)  
Real light output / frosted - 1757 lm  
Real light output / clear - 1857 lm

Models 2 and 4  
E27 (2450 lm)  
Real light output / frosted - 1624 lm  
Real light output / clear - 1698 lm

## MODELS

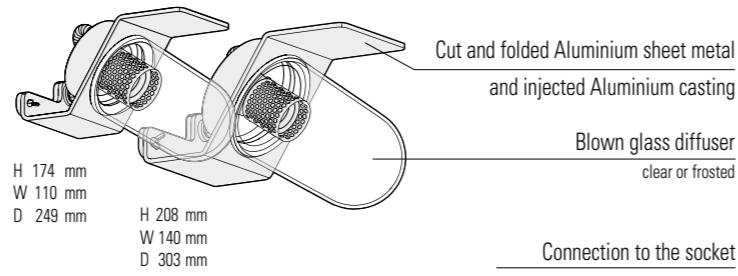

PRM Average Illuminance 20 lux p.300  
Models 1 and 3

E27 (2450 lm)	Pathway	Spacing
H 2,00m	2,00m	6,00m

## REFERENCES

Replace ●●● with the colour code

MODELS	DIFFUSERS	E27	E27 Class 3
1	CLEAR GLASS	154 001 ●●●	154 011 ●●●
	FROSTED GLASS	154 002 ●●●	154 012 ●●●
2	CLEAR GLASS	154 003 ●●●	154 013 ●●●
	FROSTED GLASS	154 004 ●●●	154 014 ●●●
3	CLEAR GLASS	154 005 ●●●	154 015 ●●●
	FROSTED GLASS	154 006 ●●●	154 016 ●●●
4	CLEAR GLASS	154 007 ●●●	154 017 ●●●
	FROSTED GLASS	154 008 ●●●	154 018 ●●●
SPARE DIFFUSERS			
CLEAR GLASS (models 1 and 2)		165 035 609	
FROSTED GLASS (models 1 and 2)		165 035 610	
CLEAR GLASS (models 3 and 4)		165 095 609	
FROSTED GLASS (models 3 and 4)		165 095 610	

**MOUNTING** Wiring entry points in grey  
Fixing kit included

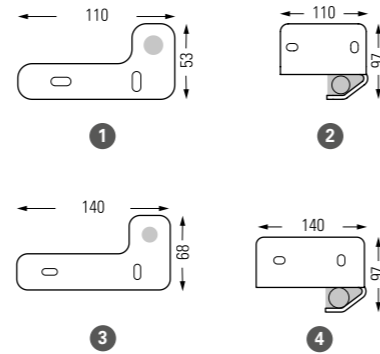

## COLOUR CODES

Replace ●●● with the colour code

	VELVET BLACK 113		OLD RUSTIC 046
	RAL 7021 BLACK GREY 107		RAL 3020 TRAFFIC RED 056
	DARK GREY 006		RAL 2004 PURE ORANGE 014
	SLATE GREY 059		RAL 1016 SULFUR YELLOW 068
	RAL 7044 SILK GREY 105		RAL 6025 FERN GREEN 109
	RAL 9010 PURE WHITE 101		

Other colours on request





# Mona

Design Stéphane Joyeux

---





# Mona

Aluminium  
Opal polycarbonate diffuser  
IP65 / IK10 / Class 2

## SOURCES

LED 35W - 2700K warm white - triac dimmable  
4500K on request

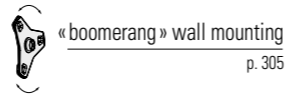
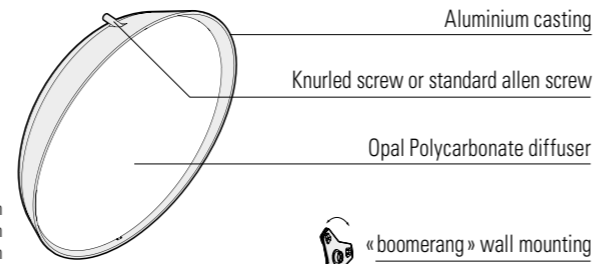

Multi-position  
wall or ceiling mounted

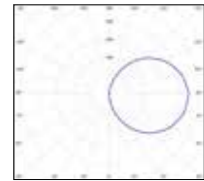

PRM Average Illuminance 20 lux p.300  
Model 1

LED 35W	Pathway	Spacing
H 2,00m	2,00m	4,00m

LED 35W  
Real light output - 1349 lm  
CRI > 80

## MODEL

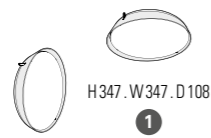

## REFERENCES

Replace ●●● with the colour code

MODEL	LED 35W 2700K warm white	SPARE DIFFUSER
1	137 004 ●●●	165 043 602

## COLOUR CODES

Replace ●●● with the colour code

	RAL 9005 JET BLACK 000		SANDSTONE 054
	VELVET BLACK 113		RAL 3013 TOMATO RED 110
	RAL 7021 BLACK GREY 107		RAL 2004 PURE ORANGE 014
	RAL 7044 SILK GREY 105		RAL 1016 SULFUR YELLOW 068
	WHITE 001		RAL 5011 STEEL BLUE 065
			BLUE 111

Other colours on request

## MOUNTING

Wiring entry point in grey  
Fixing kit included

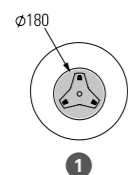



# Equix

Design Stéphane Joyeux

---



# Equix

Aluminium and Bichromated steel (base)  
Reinforced borosilicate glass diffuser  
IP55 / Class 1

## SOURCE

LED 35W - 4000K neutral white  
Initial flux - 5500 lm  
CRI > 80

## MODELS

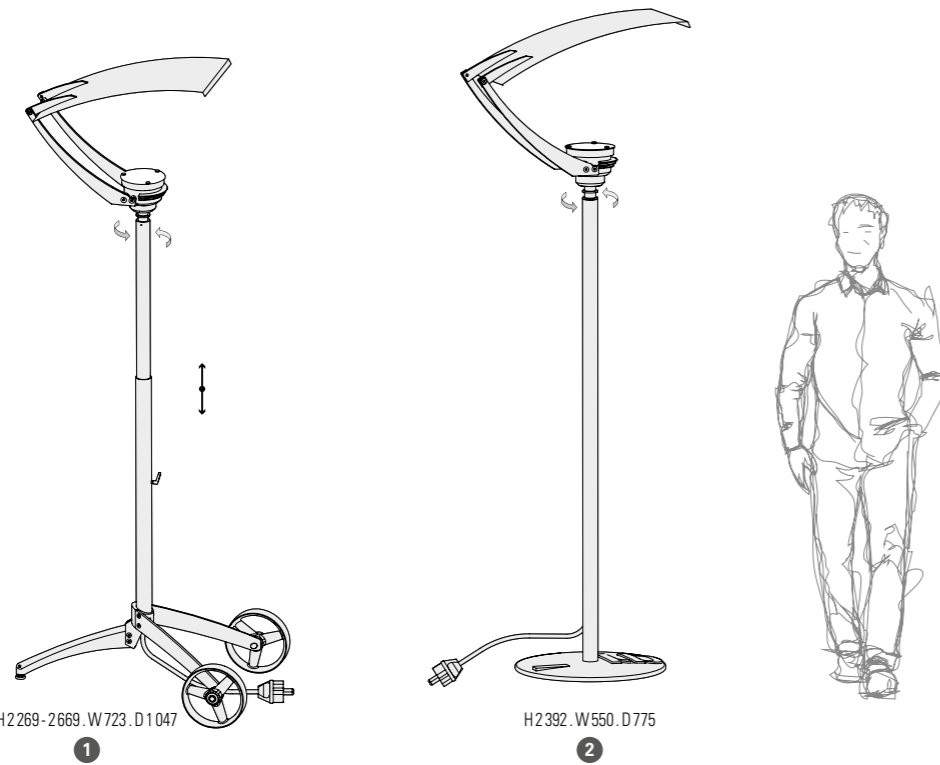
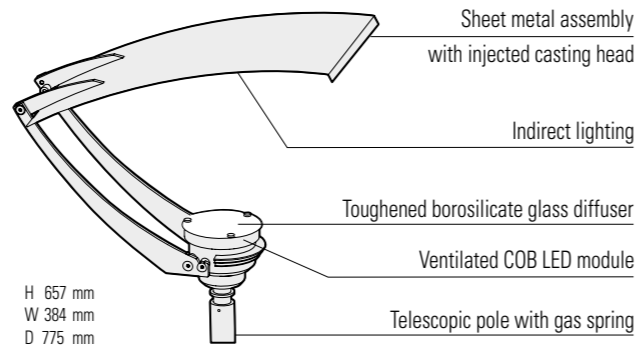

## REFERENCES

Replace ●●● with the colour code / replace (●) with the country's electrical plug code

MODELS	LED 35W 4000K neutral white
1	121 001 ●●● (●)
2	121 002 ●●● (●)
SPARE DIFFUSER	
165 026 610	

## COLOUR CODES

Replace ●●● with the colour code ↴

	RAL 7021 BLACK GREY	107
	RAL 7044 SILK GREY	105
	RAL 3005 WINE RED	066
	RAL 5011 STEEL BLUE	065

Other colours on request

## PLUG CODES

The standard Roger Pradier® plugs are SCHUKO plugs type F  
Except for French plugs, replace (●) with the country's plug code ↴

UK PLUG UK  
type G

SWISS PLUG CH  
type J





# Square

Design Patrick Norguet

---

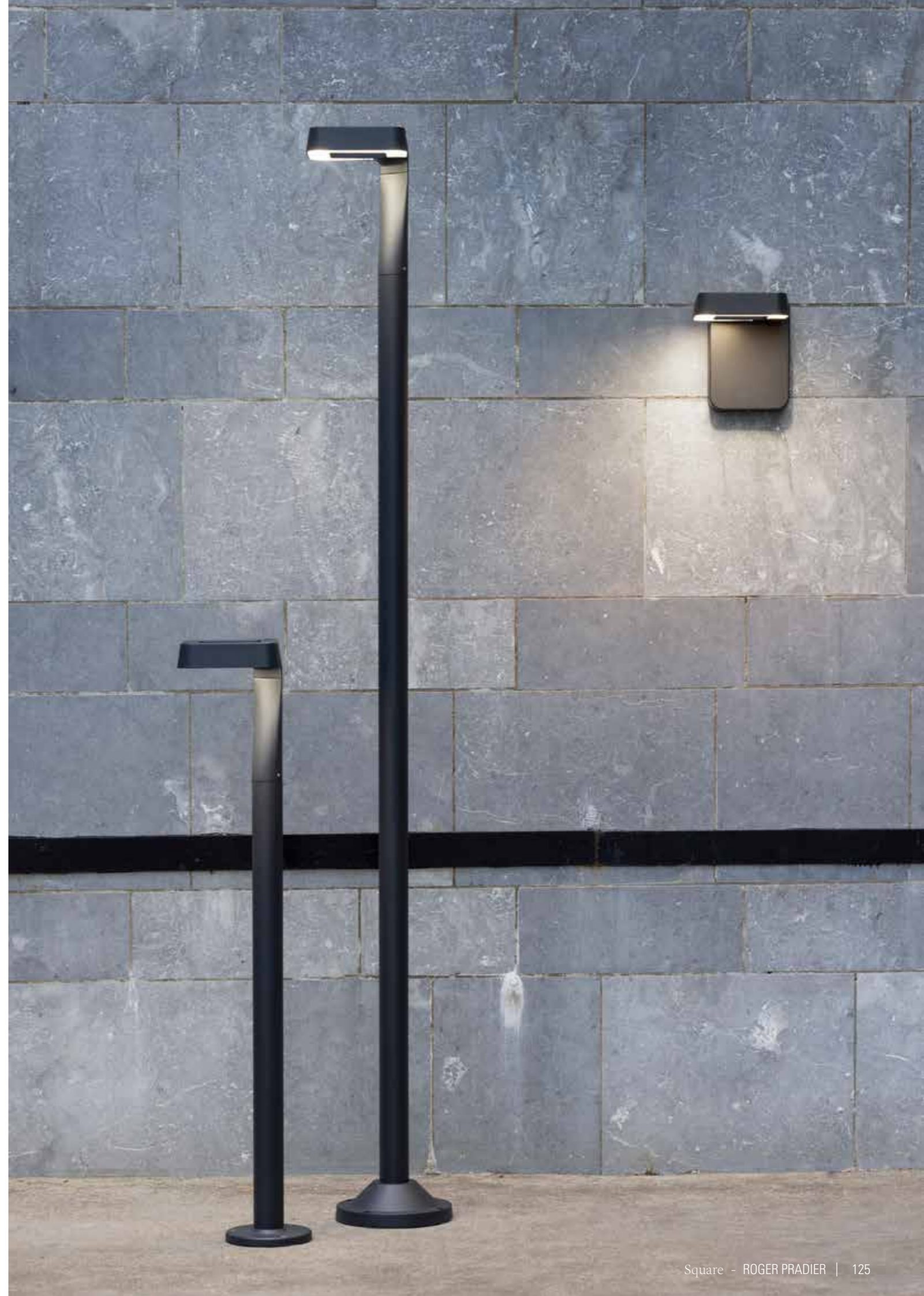

# Square

Aluminium  
Satin-finish polycarbonate diffuser  
IP65 / IK09 / Class 1

## SOURCES

LED 30W - 2700K warm white  
LED 30W - 4000K neutral white

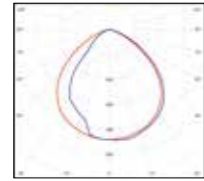

Model 1

LED 30W  
Real light output - 2716 lm  
CRI > 80

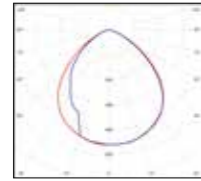

Models 2 to 4

LED 30W  
Real light output - 2691 lm  
CRI > 80

## MODELS



H259 . W226 . D271

1

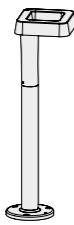

H796 . W268

2

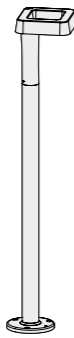

H1246 . W268

3

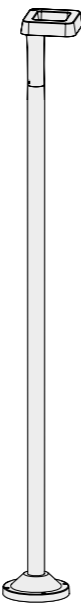

H2292 . W303

4



## REFERENCES

Replace ●●● with the colour code

MODELS	LED 30W 2700K warm white	LED 30W 4000K neutral white
1	156 002 ●●●	156 001 ●●●
2	156 004 ●●●	156 003 ●●●
3	156 006 ●●●	156 005 ●●●
4	156 008 ●●●	156 007 ●●●

## COLOUR CODES

Replace ●●● with the colour code

	RAL 7021 BLACK GREY 107		WHITE 001
	DARK GREY 006		RAL 3013 TOMATO RED 110
	RAL 7044 SILK GREY 105		LIMESTONE 053

Other colours on request

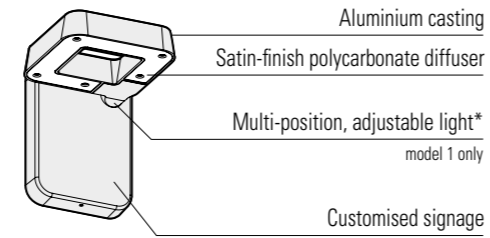

H 259 mm  
W 226 mm  
D 271 mm

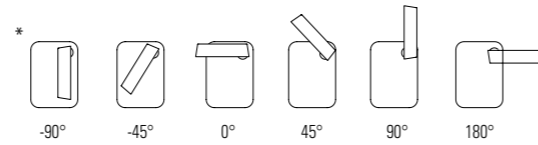



OL11

—

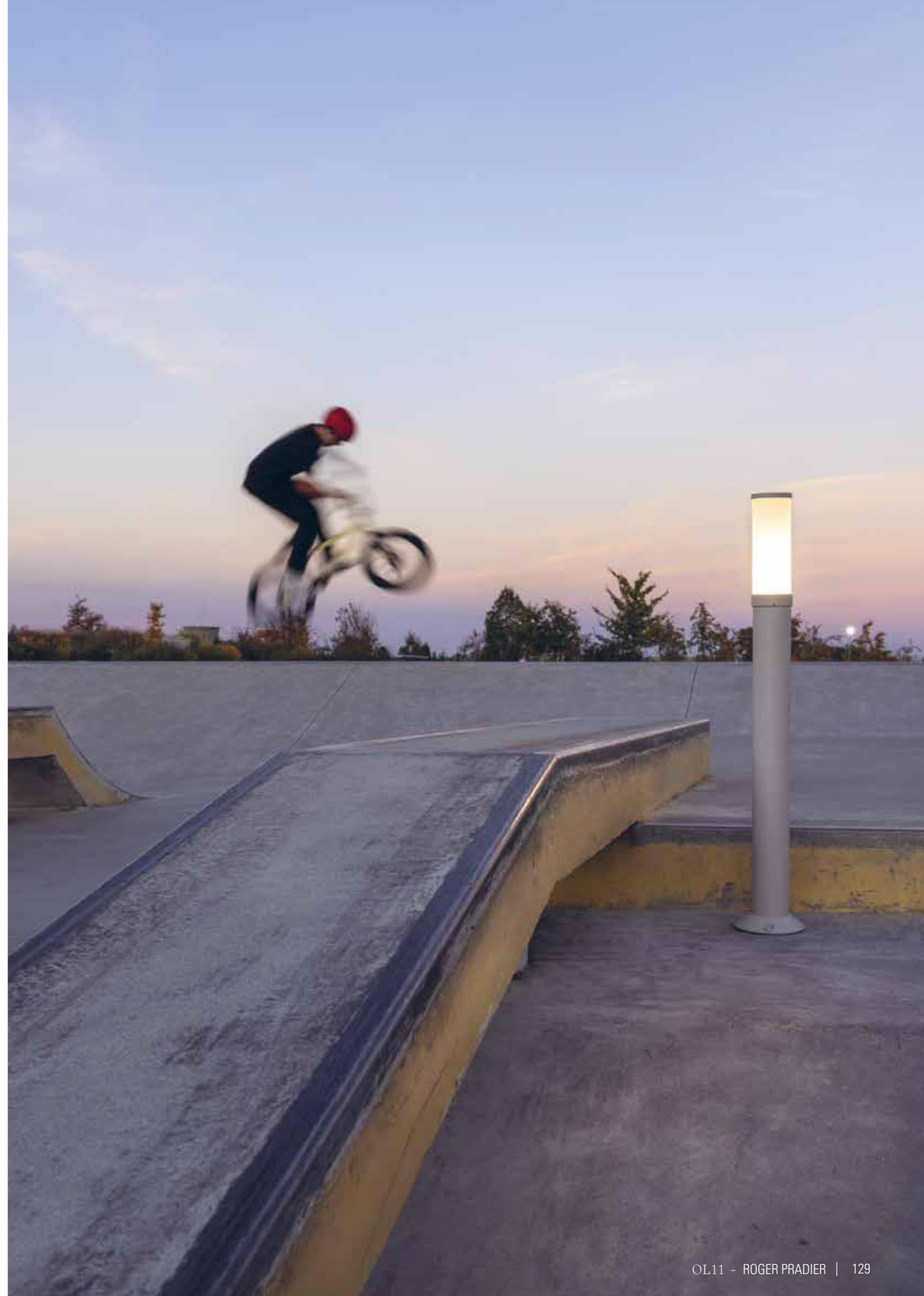

# OL11

Aluminium  
Satin-finish PMMA diffuser  
IP55 / Class 1

## SOURCE

E27 - 30W max Ø64 mm - H 200 mm max

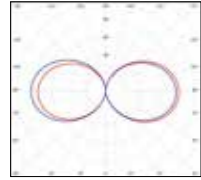

PRM Average Illuminance 20 lux p.300  
Model 4

E27 (2450 lm)	Pathway	Spacing
H 0,95 m	2,00 m	6,00 m

E27 (2450 lm)  
Real light output - 1719 lm

## MODELS

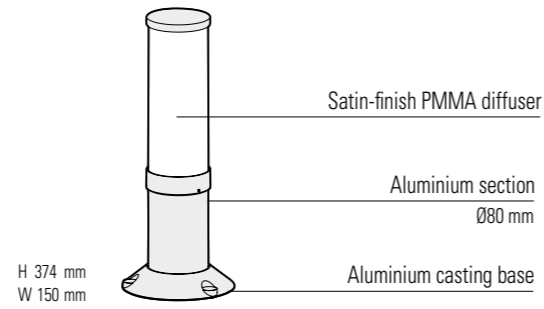
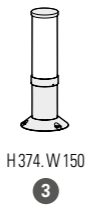
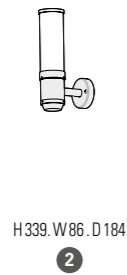
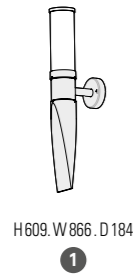

## REFERENCES

Replace ●●● with the colour code

MODELS	E27
1	142 201 ●●●
2	142 202 ●●●
3	142 203 ●●●
4	142 204 ●●●

## COLOUR CODES

Replace ●●● with the colour code

	RAL 7021 BLACK GREY	107
	RAL 7044 SILK GREY	105
	RAL 3013 TOMATO RED	110
	OLD RUSTIC	046

Other colours on request

## MOUNTING

Wiring entry points in grey  
Fixing kit included

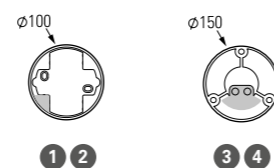



OL33







# OL33

Aluminium  
Frosted tempered glass diffuser  
IP65 / Class 1

## SOURCES

LED 18W - 3000K warm white  
LED 18W - 4500K neutral white  
LED 28W - 3000K warm white  
LED 28W - 4500K neutral white

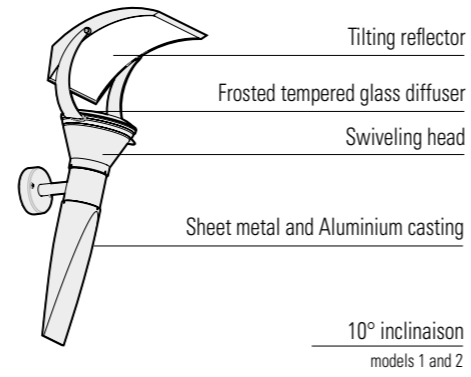

H 695 mm  
W 220 mm  
D 363 mm

10° inclinaison  
models 1 and 2

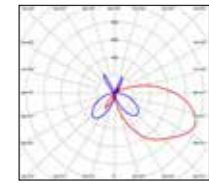

Models 2, 3 and 7

LED 18W  
Real light output - 874 lm  
CRI > 80

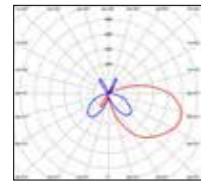

Models 1, 4 and 6

LED 28W  
Real light output - 1223 lm  
CRI > 80

PRM Average Illuminance 20 lux p.300

Model 1

LED 1x28W	Pathway	Spacing
H 2,50m	2,50m	5,00m

Model 6

LED 2x28W	Pathway	Spacing
H 3,30m	3,00m	8,00m

## MODELS



H 695 . W 220 . D 363

1



H 432 . W 220 . D 363

2

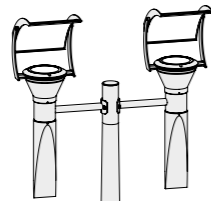

H 486 . W 220 . D 249

3

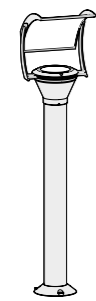

H 1035 . W 220 . D 249

4

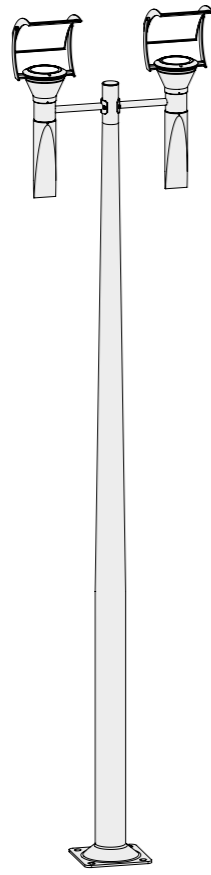

H 3300 . W 728 . D 250

6

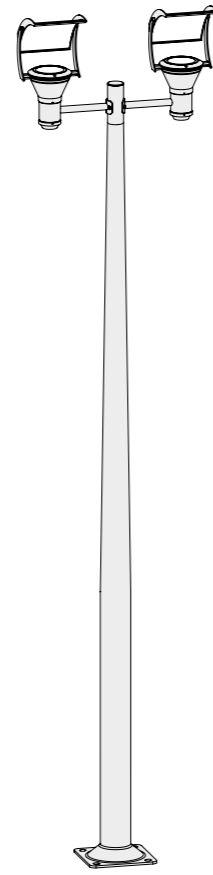

H 3300 . W 728 . D 250

7



## REFERENCES

Replace ●●● with the colour code

MODELS

1  
2  
3  
4  
6  
7

	LED 18W 3000K warm white	LED 18W 4500K neutral white	LED 28W 3000K warm white	LED 28W 4500K neutral white
1			144 202 ●●●	144 203 ●●●
2	144 205 ●●●	144 206 ●●●		
3	144 208 ●●●	144 209 ●●●		
4			144 211 ●●●	144 212 ●●●
6			144 214 ●●●	144 215 ●●●
7	144 217 ●●●	144 218 ●●●		

## COLOUR CODES

Replace ●●● with the colour code

■	RAL 7021 BLACK GREY	107
■	RAL 7044 SILK GREY	105
■	RAL 9010 PURE WHITE	101
■	OLD RUSTIC	046
■	RAL 3013 TOMATO RED	110
■	RAL 2004 PURE ORANGE	014

Other colours on request

## MOUNTING

Wiring entry points in grey  
Fixing kit included (except models 6 and 7)  
Anchor bolts on request (models 6 and 7) p. 302

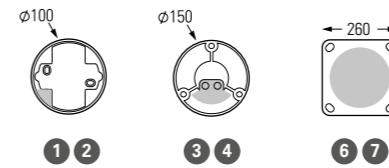

# Ibuk

Design Stéphane Joyeux

Label VIA 2015

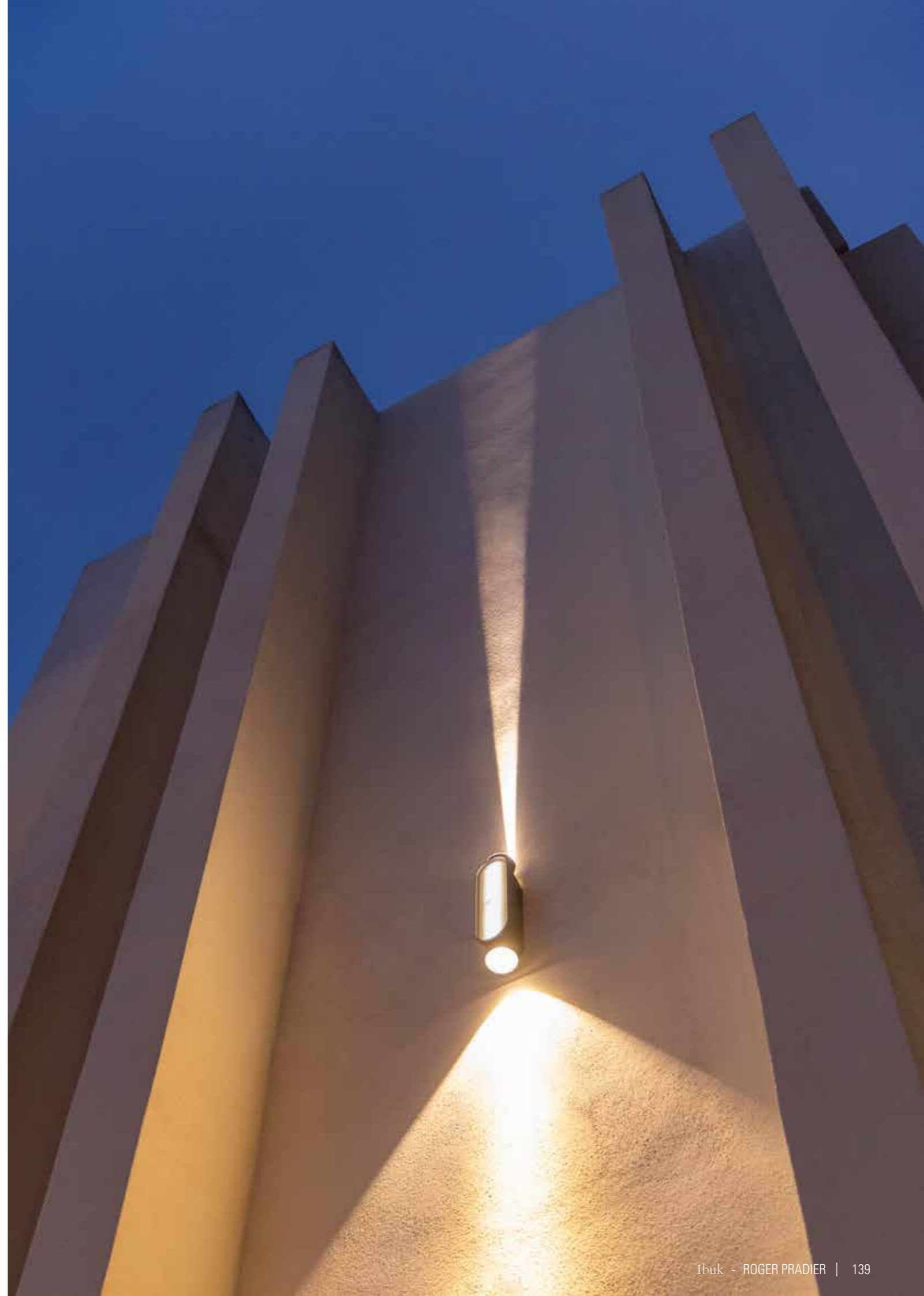



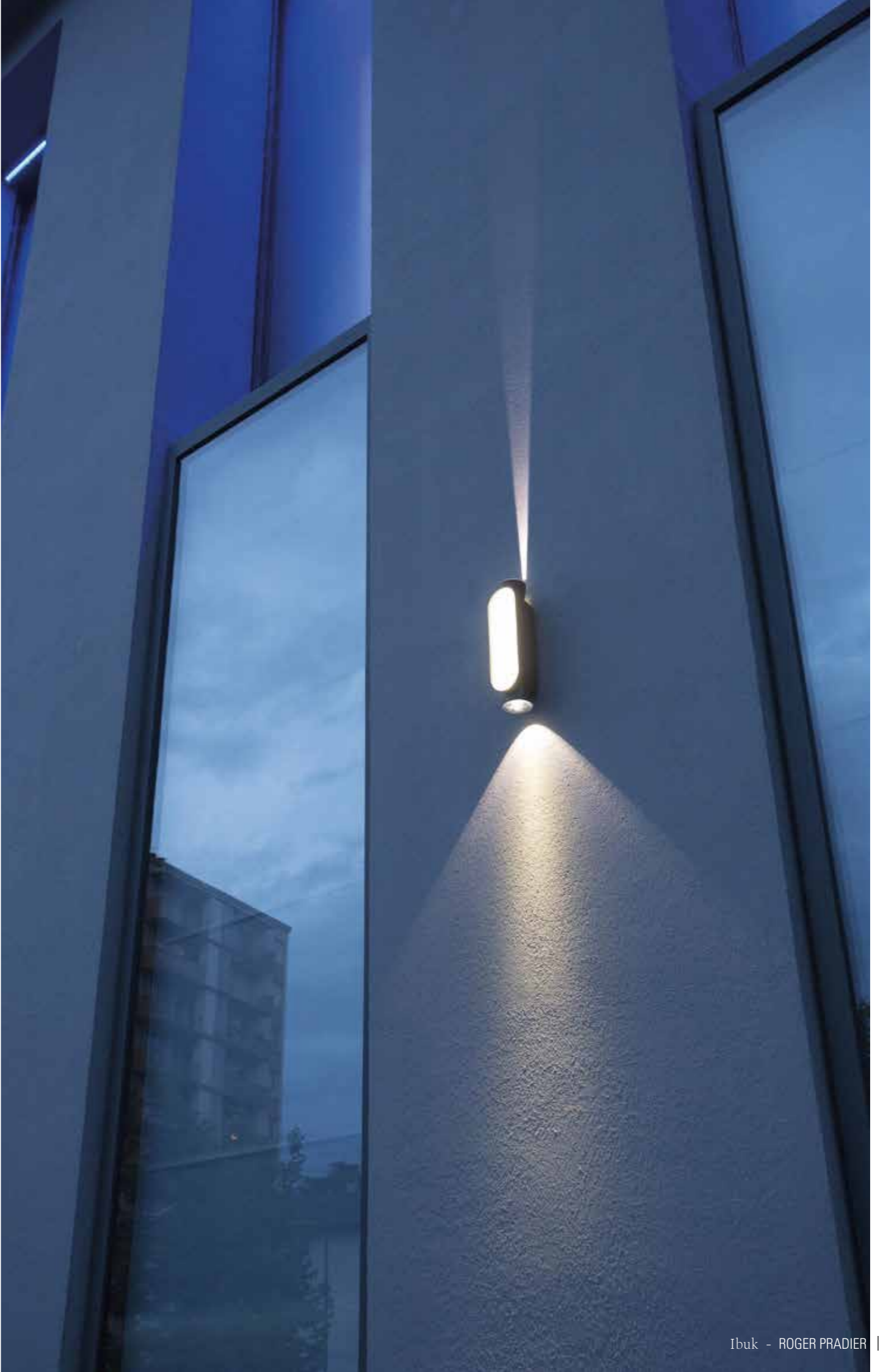

# Ibuk

Aluminium  
 Black or white polycarbonate front diffuser  
 Clear polycarbonate Up & Down diffusers Ø80  
 IP65 / IK10 / Class 2

## SOURCES

LED 3x4,5W - 3000K warm white  
 LED 3x4,5W - 4300K neutral white

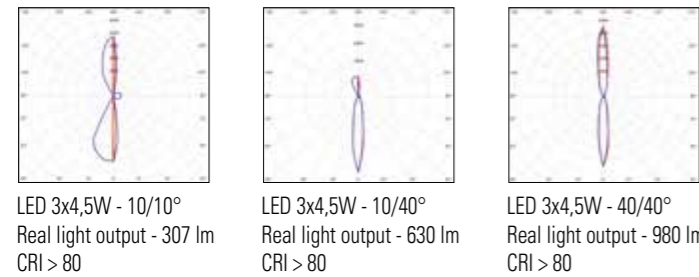
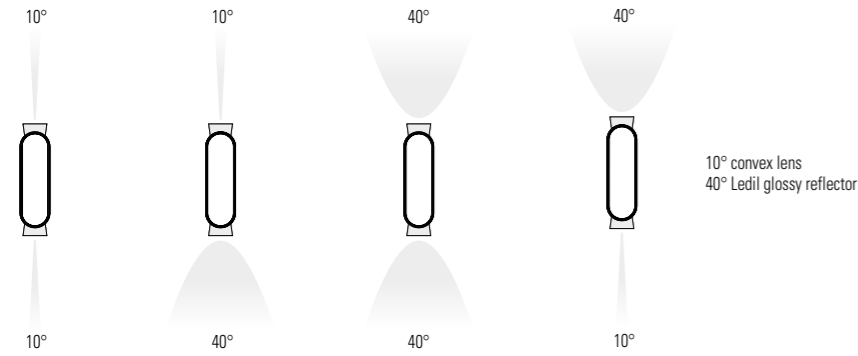

## MODEL



## DIFFUSERS

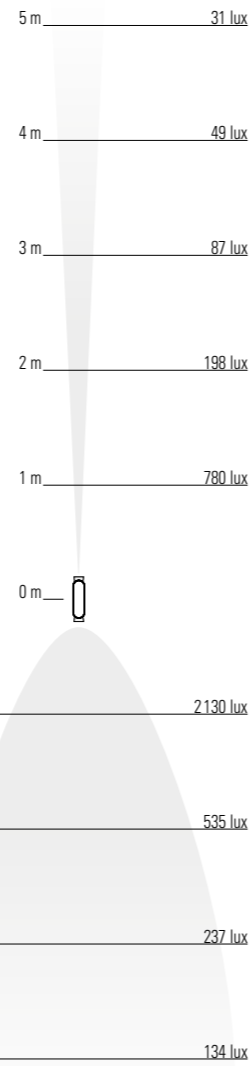
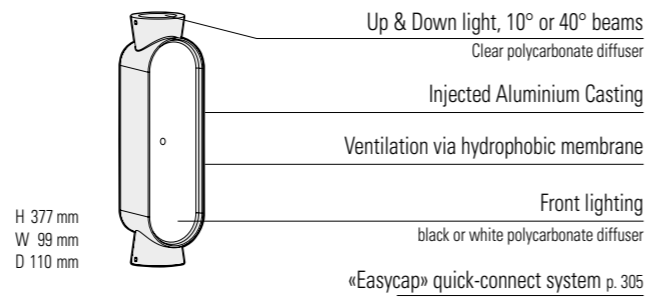
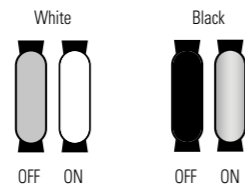

# Ibuk

## REFERENCES

Replace ●●● with the colour code

### Warm white

MODEL	FRONT DIFFUSER	LED 3x4,5W - 10/10° 3000K warm white	LED 3x4,5W - 10/40° 3000K warm white	LED 3x4,5W - 40/40° 3000K warm white
1	WHITE POLYCARBONATE	126 101 ●●●	126 102 ●●●	126 103 ●●●
	BLACK POLYCARBONATE	126 104 ●●●	126 105 ●●●	126 106 ●●●

### Neutral white

MODEL	FRONT DIFFUSER	LED 3x4,5W - 10/10° 4300K neutral white	LED 3x4,5W - 10/40° 4300K neutral white	LED 3x4,5W - 40/40° 4300K neutral white
1	WHITE POLYCARBONATE	126 107 ●●●	126 108 ●●●	126 109 ●●●
	BLACK POLYCARBONATE	126 110 ●●●	126 111 ●●●	126 112 ●●●

## COLOUR CODES

Replace ●●● with the colour code

	RAL 7021 BLACK GREY	107		VELVET BLACK	113
	RAL 7044 SILK GREY	105		DARK GREY	006
	RAL 9010 PURE WHITE	101		BLUE	111
	RAL 3005 WINE RED	066		SANDSTONE	054
	RAL 3013 TOMATO RED	110	Other colours on request		
	RAL 3020 TRAFFIC RED	056			
	RAL 2004 PURE ORANGE	014			
	RAL 1016 SULFUR YELLOW	068			
	RAL 6025 FERN GREEN	109			

## MOUNTING

Wiring entry point in grey  
 Fixing kit included





# Bamboo

Design Stéphane Joyeux

---

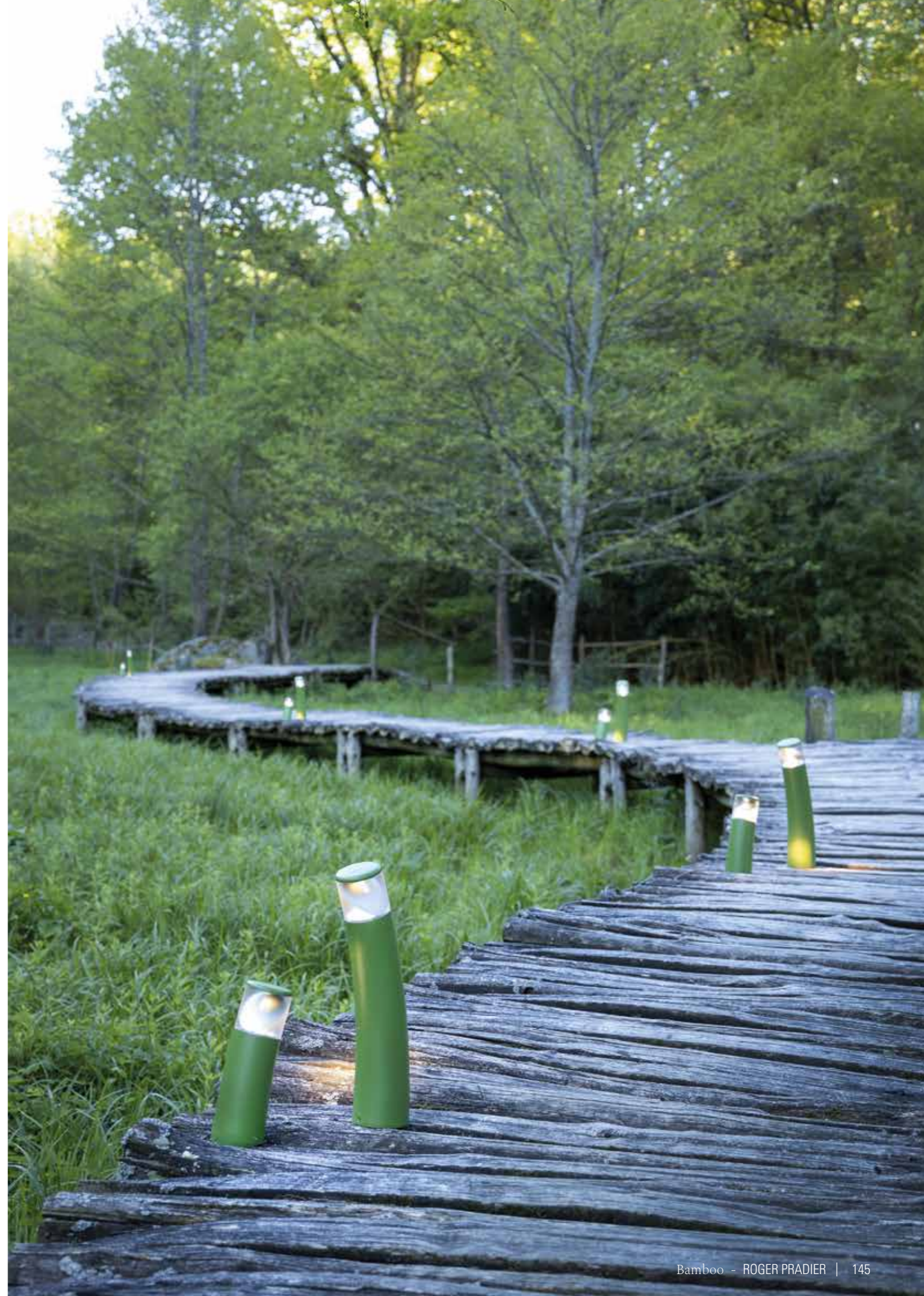



# Bamboo

Aluminium  
 Clear or opal satin-finish polycarbonate diffuser  
 IP44 (models 1 and 2) / IP54 (model 3) / IP65 (model 3) on request / Class 1

## SOURCE

GU10 PAR16 LED - 23W max H 80 mm max

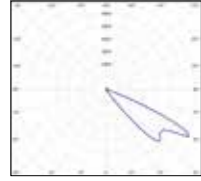

Models 1 to 3

GU10 (575 lm)  
 Real light output/clear - 487 lm

## MODELS

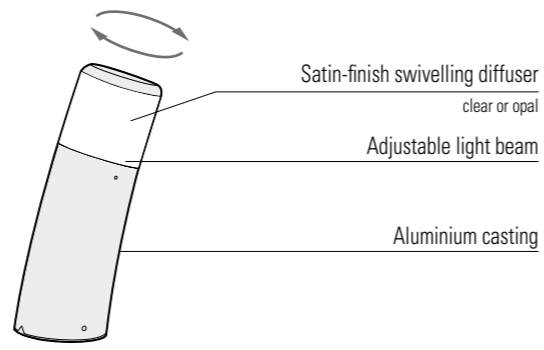

## REFERENCES

Replace ●●● with the colour code

MODELS	DIFFUSERS	GU10 PAR16 LED
1	CLEAR POLYCARBONATE	105 001 ●●●
	OPAL POLYCARBONATE	105 002 ●●●
2	CLEAR POLYCARBONATE	105 003 ●●●
	OPAL POLYCARBONATE	105 004 ●●●
3	CLEAR POLYCARBONATE	105 005 ●●●
	OPAL POLYCARBONATE	105 006 ●●●
SPARE DIFFUSERS		
	CLEAR POLYCARBONATE	165 011 601
	OPAL POLYCARBONATE	165 011 602

## MOUNTING

Wiring entry points in grey  
 Fixing kit included

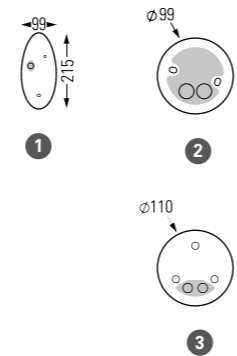

## COLOUR CODES

Replace ●●● with the colour code

	DARK GREY 006		RAL 3020 TRAFFIC RED 056
	SLATE GREY 059		RAL 2004 PURE ORANGE 014
	RAL 7044 SILK GREY 105		RAL 6025 FERN GREEN 109
	RAL 9010 PURE WHITE 101		RAL 6018 YELLOW GREEN 015
	SANDSTONE 054		
	OLD RUSTIC 046		

Other colours on request





# Bermude

Design Stéphane Joyeux

---



# Bermude

Aluminium  
Frosted glass diffuser  
IP44 / Class 1

## SOURCE

E27 - 105W max Ø68 mm - H180 mm max

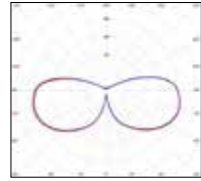

E27 (2450 lm)  
Real light output - 1230 lm

PRM Average Illuminance 20 lux p.300  
Model 5

E27 (2450lm)	Pathway	Spacing
H 2,20m	2,00m	3,00m

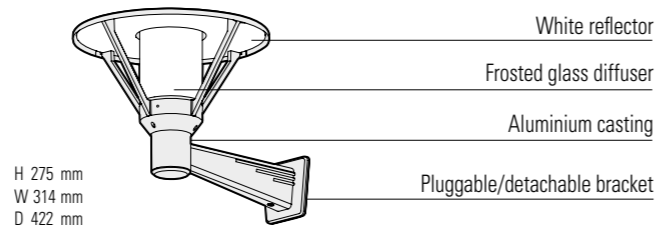

## MODELS



H275 .W314 .D422

1

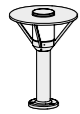

H451 .W314

2

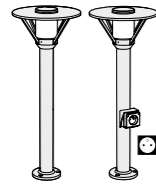

H813 .W314

3

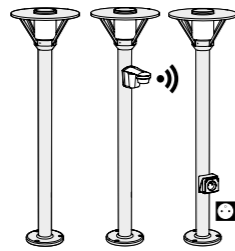

H1124 .W314

4

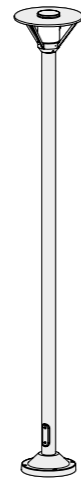

H2169 .W314

5

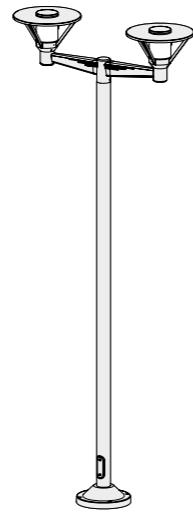

H2294 .W314 .D914

6



## REFERENCES

Replace ●●● with the colour code / replace (●) with the country's electrical socket code

MODELS	E27	E27 + SENSOR	SOCKETS	CORNER PLATE
1	115 001 ●●●	115 002 ●●●		147 006 ●●●
2	115 003 ●●●			
3	115 004 ●●●		115 005 ●●●(●)	
4	115 006 ●●●	115 007 ●●●	115 008 ●●●(●)	
5	115 009 ●●●			
6	115 010 ●●●			
SPARE DIFFUSER				
	165 019 ●●●			

## COLOUR CODES

Replace ●●● with the colour code

RAL 7021 BLACK GREY	107	OLD RUSTIC	046
DARK GREY	006	RAL 6009 FIR GREEN	067
RAL 7044 SILK GREY	105	RAL 5011 STEEL BLUE	065
WHITE	001	BLUE	111

Other colours on request

## SOCKET CODES

Except for French socket, replace (●) with country's socket code

SCHUKO SOCKET SK type F	SWISS SOCKET CH type J
-------------------------	------------------------

## MOUNTING

Wiring entry points in grey  
Fixing kit included

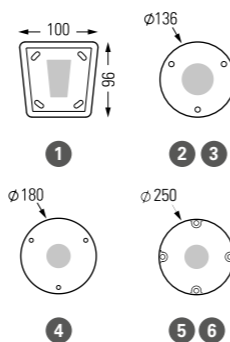



# Montana

---



# Montana

Aluminium - Reflector : White Aluminium, Lacquered copper or Raw copper  
 Clear or frosted glass diffuser  
 IP44 / Class 1

## SOURCE

E27 - 105W max Ø68 mm - H120 mm max

## MODELS



H 545 . W 282  
 H 315 . W 282 . D 385  
 H 306 . W 282 . D 358

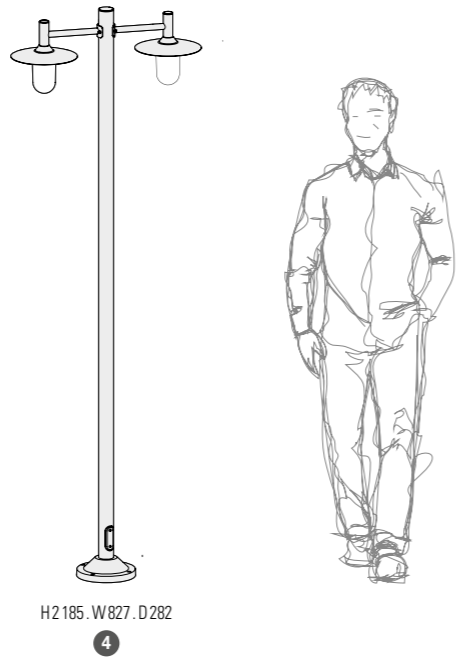
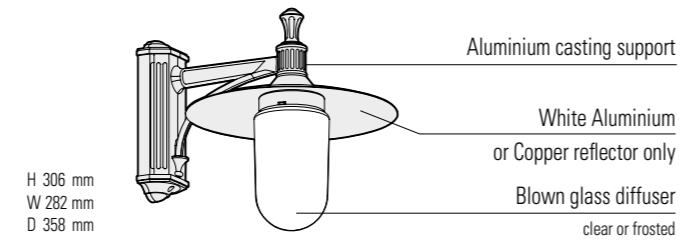

## REFERENCES

Replace ●●● with the colour code

MODELS	DIFFUSERS	WHITE ALUMINIUM REFLECTOR E27	LACQUERED COPPER REFLECTOR E27	RAW COPPER REFLECTOR E27	CORNER PLATES
1	CLEAR GLASS	139 001 ●●●	139 002 ●●●	139 017 ●●●	
	FROSTED GLASS	139 003 ●●●	139 004 ●●●	139 018 ●●●	
2	CLEAR GLASS	139 005 ●●●	139 006 ●●●	139 019 ●●●	147 002 ●●●
	FROSTED GLASS	139 007 ●●●	139 008 ●●●	139 020 ●●●	
3	CLEAR GLASS	139 009 ●●●	139 010 ●●●	139 021 ●●●	147 004 ●●●
	FROSTED GLASS	139 011 ●●●	139 012 ●●●	139 022 ●●●	
4	CLEAR GLASS	139 013 ●●●	139 014 ●●●	139 023 ●●●	
	FROSTED GLASS	139 015 ●●●	139 016 ●●●	139 024 ●●●	
SPARE DIFFUSERS					
	CLEAR GLASS		165 012 609		
	FROSTED GLASS		165 012 610		

## COLOUR CODES

Replace ●●● with the colour code

■	RAL 7021 BLACK GREY	107
■	SLATE GREY	059
■	WHITE	001
■	RAL 5011 STEEL BLUE	065
■	RAL 6009 BRITISH GREEN	019
■	RAL 6009 FIR GREEN	067
■	GREEN PATINA	008
■	OLD RUSTIC	046
■	RAL 3005 WINE RED	066

Other colours on request

## MOUNTING

Wiring entry points in grey  
 Fixing kit included

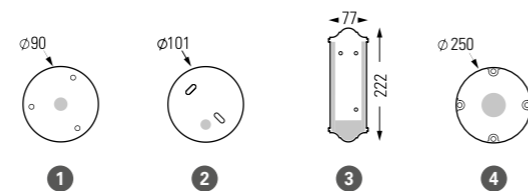

Raw copper 082



Lacquered copper 080





# Kerlouan

Design Stéphane Joyeux

---



# Kerlouan

Aluminium  
Satin-finish polycarbonate diffuser  
IP44 / Class 1

## SOURCE

E27 - 105W max Ø66 mm - H145 mm max

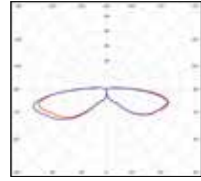

E27 (2450 lm)  
Real light output - 493 lm

## MODELS



H206 . W316 . D 405

1



H386 . W316

2

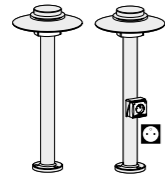

H750 . W316

3

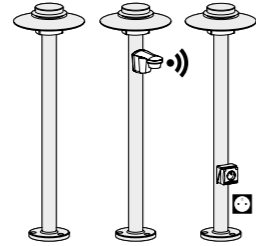

H1059 . W316

4

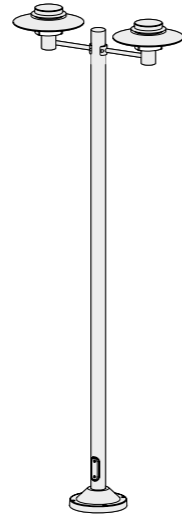

H2251 . W826 . D 316

6

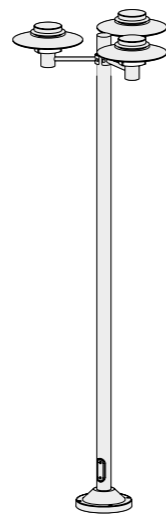

H2251 . W758

8

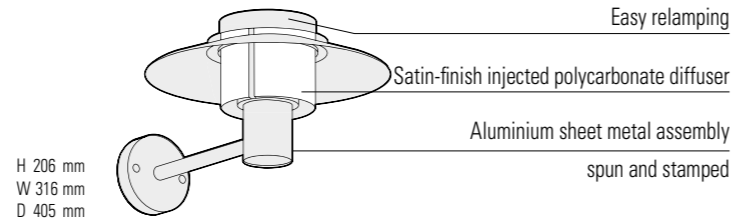

PRM Average Illuminance 20 lux p.300  
Model 4

E27 (2450 lm)	Pathway	Spacing
H 1,10m	1,50m	3,00m

## REFERENCES

Replace ●●● with the colour code / replace (●) with the country's electrical socket code

MODELS	E27	E27 + SENSOR	SOCKETS	CORNER PLATE
1	128 001 ●●●			147 005 ●●●
2	128 002 ●●●			
3	128 003 ●●●		128 004 ●●●(●)	
4	128 005 ●●●	128 007 ●●●	128 006 ●●●(●)	
6	128 008 ●●●			
8	128 009 ●●●			
SPARE DIFFUSER				
165 031 601				

## COLOUR CODES

Replace ●●● with the colour code

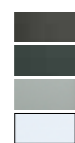

DARK GREY 006  
SLATE GREY 059  
METAL GREY 023  
WHITE 001



RAL 6009 BRITISH GREEN 019  
RAL 6009 FIR GREEN 067  
RAL 5011 STEEL BLUE 065  
OLD RUSTIC 046

Other colours on request

## SOCKET CODES

Except for French socket, replace (●) with country's socket code



SCHUKO SOCKET SK  
type F



SWISS SOCKET CH  
type J

## MOUNTING

Wiring entry points in grey  
Fixing kit included

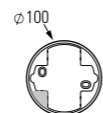

1

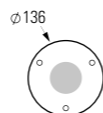

2 3

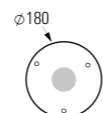

4

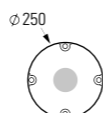

6 8





# Belcour

Design Stéphane Joyeux

---







Lacquered brushed copper 084



Lacquered brushed copper 084



Raw copper 082

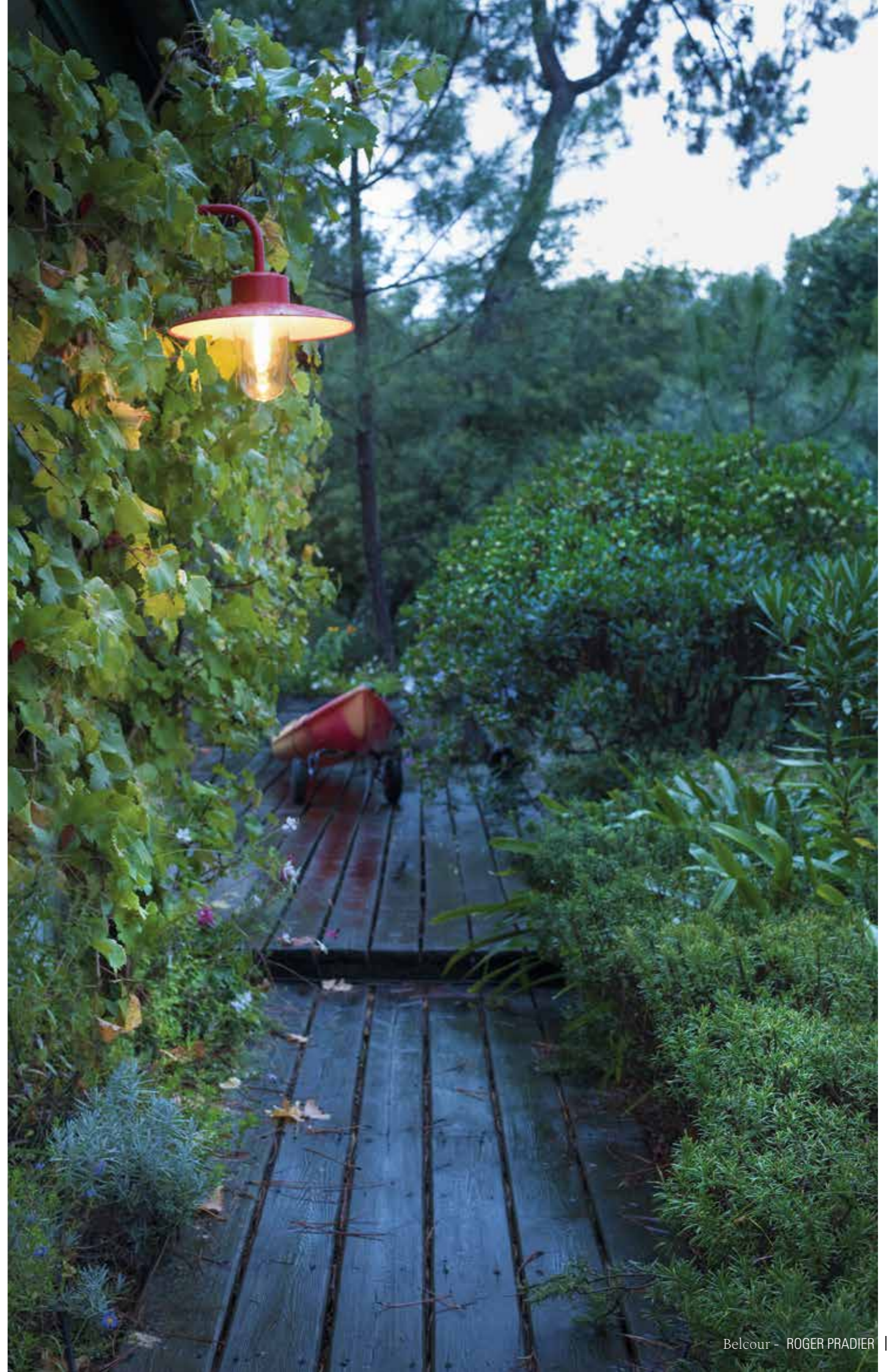



# Belcour

Aluminium - Reflector : Aluminium, Lacquered brushed copper or Raw copper  
Clear or frosted glass diffuser  
IP44 / Class 1

## SOURCE

E27 - 60W max Ø 68 mm - H 160 mm max

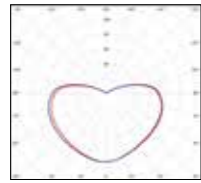

PRM Average Illuminance 20 lux p.300  
Model 4

E27 (2450 lm)	Pathway	Spacing
H 2,20m	2,00m	6,00m

E27 (2450 lm)  
Real light output/frosted - 1585 lm  
Real light output/clear - 1583 lm

## MODELS



H267 . W320 . D419

1



H398 . W320

2



H295 . W320 . D421

8

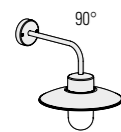

H385 . W320 . D466

9

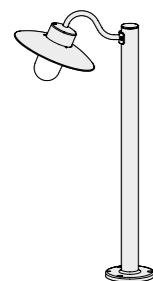

H1016 . W320 . D517

3

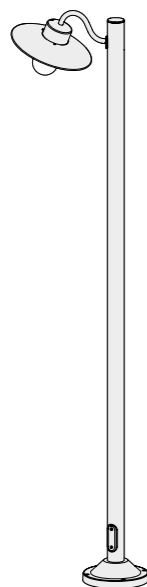

H2196 . W320 . D552

4

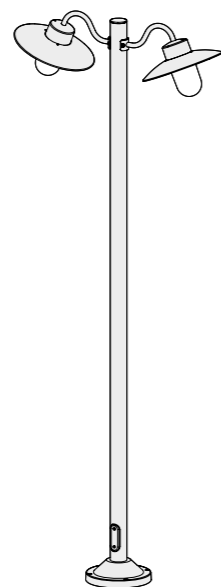

H2196 . W855 . D320

5

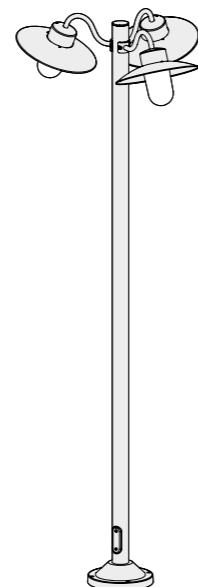

H2196 . W786

6

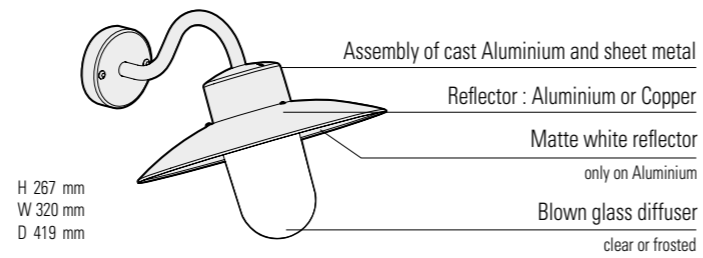

## REFERENCES

Replace ●●● with the colour code or the material code

MODELS	DIFFUSERS	E27	CORNER PLATES
1	CLEAR GLASS	106 001 ●●●	147 005 ●●●
	FROSTED GLASS	106 002 ●●●	
2	CLEAR GLASS	106 003 ●●●	
	FROSTED GLASS	106 004 ●●●	
3	CLEAR GLASS	106 005 ●●●	
	FROSTED GLASS	106 006 ●●●	
4	CLEAR GLASS	106 007 ●●●	
	FROSTED GLASS	106 008 ●●●	
5	CLEAR GLASS	106 009 ●●●	
	FROSTED GLASS	106 010 ●●●	
6	CLEAR GLASS	106 011 ●●●	
	FROSTED GLASS	106 012 ●●●	
8	CLEAR GLASS	106 013 ●●●	147 005 ●●●
	FROSTED GLASS	106 014 ●●●	
9	CLEAR GLASS	106 015 ●●●	147 005 ●●●
	FROSTED GLASS	106 016 ●●●	
SPARE DIFFUSERS			
	CLEAR GLASS	165 035 609	
	FROSTED GLASS	165 035 610	

## COLOUR CODES

Replace ●●● with the colour code

	RAL 9005 JET BLACK	000
	SLATE GREY	059
	METAL GREY	023
	WHITE	001
	OLD RUSTIC	046
	SANDSTONE	054
	RAL 6009 BRITISH GREEN	019
	RAL 6009 FIR GREEN	067
	RAL 6018 YELLOW GREEN	015
	RAL 3020 TRAFFIC RED	056
	RAL 5009 MATTE AZURE BLUE	134

Other colours on request

## MATERIAL CODES

Replace ●●● with the material code

	LACQUERED BRUSHED COPPER	084
	RAW COPPER	082 See pages 12-13

With bracket and pole Velvet black 113 for all materials

## MOUNTING

Wiring entry points in grey  
Fixing kit included

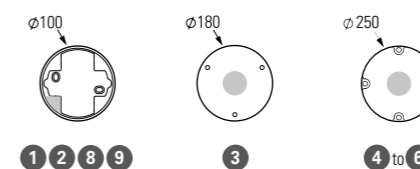

# Aubanne

Design Stéphane Joyeux

---









# Aubanne

Aluminium  
Clear or frosted glass diffuser  
Opal polycarbonate reflector  
IP44 / Class 1

## SOURCE

E27 - 23W max Ø 68mm - H 150 mm max

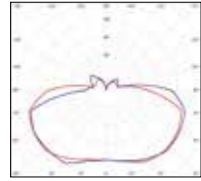

E27 (2450 lm)  
Real light output/frosted - 1633 lm

## MODELS

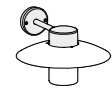

H220 . W328 . D391  
**1**



H296 . W328  
**2**

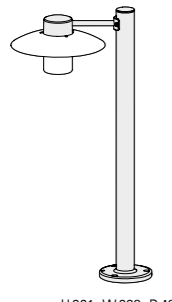

H961 . W328 . D489  
**3**

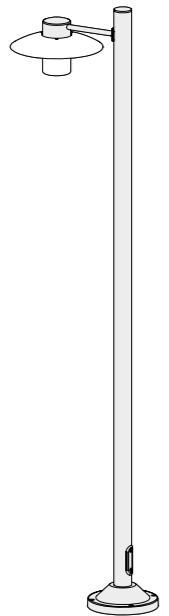

H2185 . W328 . D559  
**4**

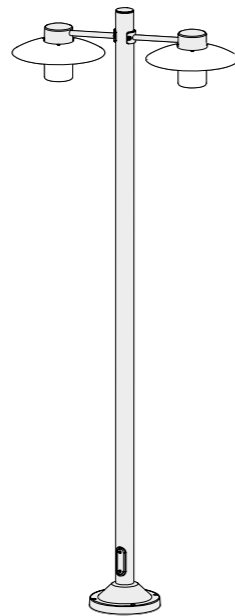

H2185 . W828 . D328  
**5**

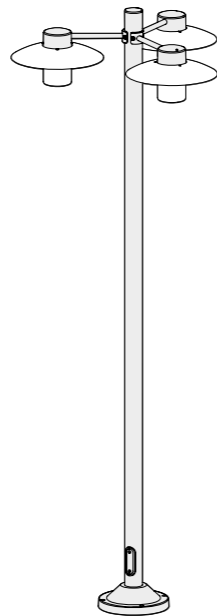

H2185 . W796  
**6**

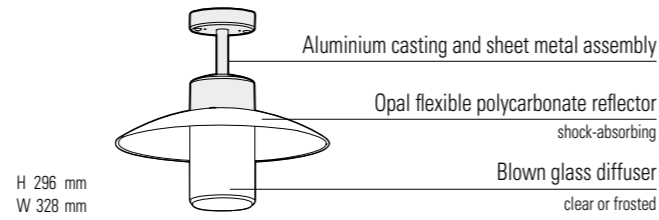

## REFERENCES

Replace **•••** with the colour code

MODELS	DIFFUSERS	E27	CORNER PLATE
<b>1</b>	CLEAR GLASS	101 001 •••	147 005 •••
	FROSTED GLASS	101 002 •••	
<b>2</b>	CLEAR GLASS	101 003 •••	
	FROSTED GLASS	101 004 •••	
<b>3</b>	CLEAR GLASS	101 005 •••	
	FROSTED GLASS	101 006 •••	
<b>4</b>	CLEAR GLASS	101 007 •••	
	FROSTED GLASS	101 008 •••	
<b>5</b>	CLEAR GLASS	101 009 •••	
	FROSTED GLASS	101 010 •••	
<b>6</b>	CLEAR GLASS	101 011 •••	
	FROSTED GLASS	101 012 •••	
SPARE DIFFUSERS			
	CLEAR GLASS	165 001 609	
	FROSTED GLASS	165 001 610	

## COLOUR CODES

Replace **•••** with the colour code ↴

	RAL 9010 PURE WHITE	<b>101</b>
	DARK GREY	<b>006</b>
	SLATE GREY	<b>059</b>
	METAL GREY	<b>023</b>
	SANDSTONE	<b>054</b>
	OLD RUSTIC	<b>046</b>
	RAL 5011 STEEL BLUE	<b>065</b>

Other colours on request

## MOUNTING

Wiring entry points in grey  
Fixing kit included

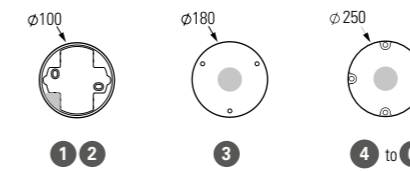



# Newpark

---









# Newpark

Aluminium  
Clear or frosted glass diffuser  
IP44 / Class 1

## SOURCE

E27 - 105W max Ø68 mm - H120 mm max

## MODELS



H329 . W251 . D340

1

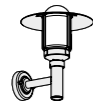

H328 . W251 . D280

2



H316 . W251

3

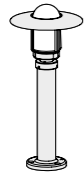

H571 . W251

4

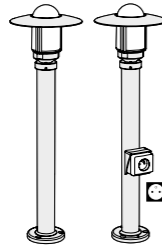

H851 . W251

5

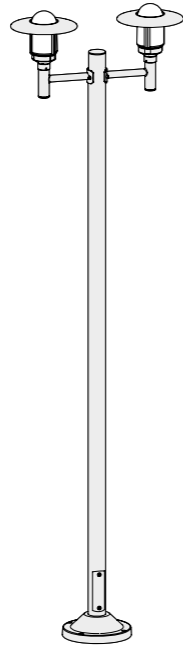

H2358 . W664 . D251

6

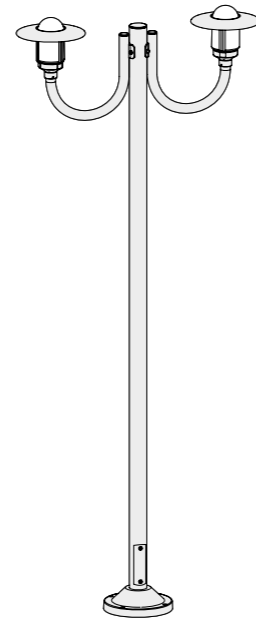

H2238 . W908 . D251

7

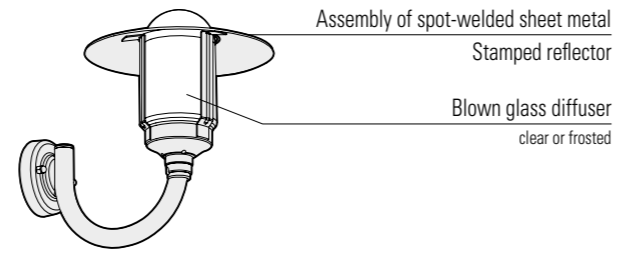

## REFERENCES

Replace ●●● with the colour code / replace (●) with the country's electrical socket code

MODELS	DIFFUSERS	E27	SOCKETS	CORNER PLATES
1	CLEAR GLASS	141 001 ●●●		147 002 ●●●
	FROSTED GLASS	141 002 ●●●		147 002 ●●●
2	CLEAR GLASS	141 003 ●●●		147 002 ●●●
	FROSTED GLASS	141 004 ●●●		147 002 ●●●
3	CLEAR GLASS	141 005 ●●●		
	FROSTED GLASS	141 006 ●●●		
4	CLEAR GLASS	141 007 ●●●		
	FROSTED GLASS	141 008 ●●●		
5	CLEAR GLASS	141 009 ●●●	141 010 ●●● (●)	
	FROSTED GLASS	141 011 ●●●	141 012 ●●● (●)	
6	CLEAR GLASS	141 013 ●●●		
	FROSTED GLASS	141 014 ●●●		
7	CLEAR GLASS	141 015 ●●●		
	FROSTED GLASS	141 016 ●●●		
SPARE DIFFUSERS				
	CLEAR GLASS	165 035 609		
	FROSTED GLASS	165 035 610		

## COLOUR CODES

Replace ●●● with the colour code ↓

	RAL 9005 JET BLACK	000
	SLATE GREY	059
	METAL GREY	023
	WHITE	001
	RAL 6009 BRITISH GREEN	019
	RAL 6009 FIR GREEN	067
	RAL 3005 WINE RED	066
	RAL 5011 STEEL BLUE	065
	BLUE	111

Other colours on request

## SOCKET CODES

Except for French socket, replace (●) with country's socket code ↓

	SCHUKO SOCKET SK	SWISS SOCKET CH
	type F	type J

## MOUNTING

Wiring entry points in grey  
Fixing kit included

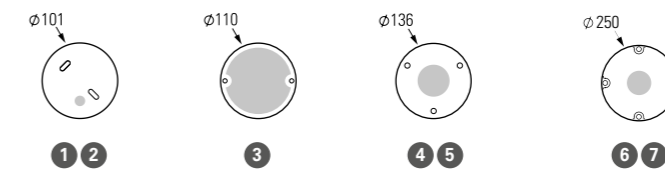

## Boléro

—





# Boléro

Aluminium  
Prismatic clear glass diffuser  
IP23 / Class 1

## SOURCE

E27 - 105W max H150 mm max

## MODELS



H 544 . W 247

1



H 394 . W 247 . D 470

2



H 303 . W 247 . D 388

3

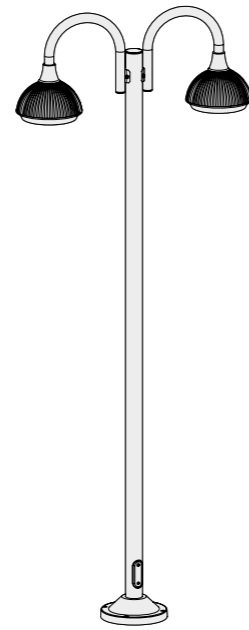

H 2345 . W 904 . D 250

5

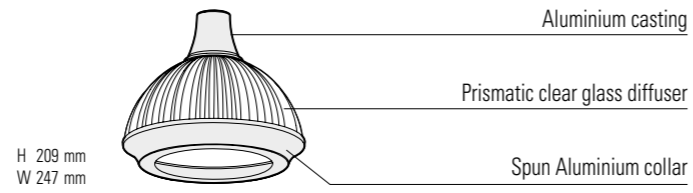

## REFERENCES

Replace **•••** with the colour code

MODELS	E27	CORNER PLATES
1	152 001 •••	
2	152 002 •••	147 003 •••
3	152 003 •••	147 001 •••
5	152 004 •••	
SPARE DIFFUSER		
	165 059 •••	

## MOUNTING

Wiring entry points in grey  
Fixing kit included

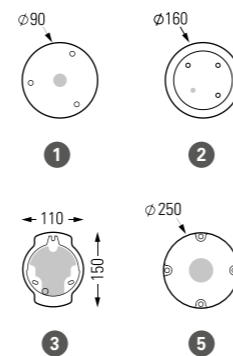

## COLOUR CODES

Replace **•••** with the colour code

	RAL 9005 JET BLACK 000		RAL 6009 BRITISH GREEN 019
	SLATE GREY 059		RAL 6009 FIR GREEN 067
	WHITE 001		RAL 6025 FERN GREEN 109
	LIMESTONE 053		RAL 5011 STEEL BLUE 065

Other colours on request

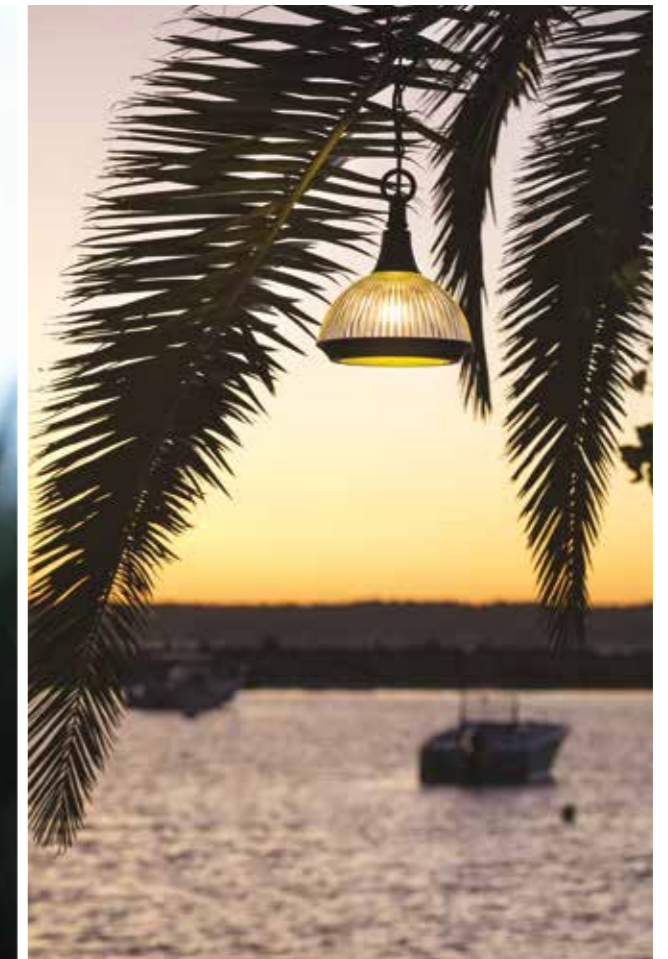

# Dallas







# Dallas

Aluminium  
Opal or smoked polycarbonate diffuser  
IP44 / IK10 / Class 1

## SOURCE

E27 - 75W max H200 mm

## MODELS

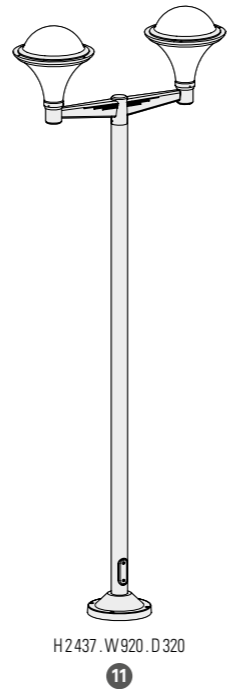
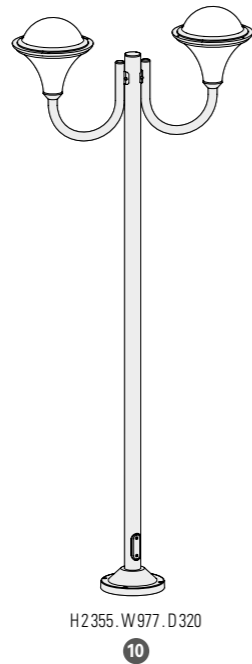
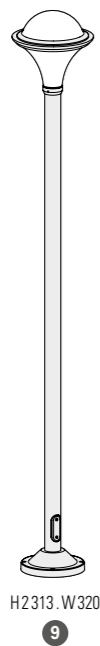
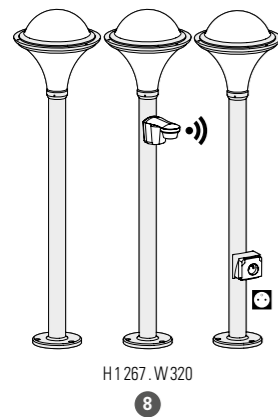
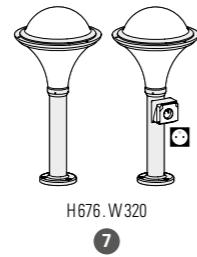
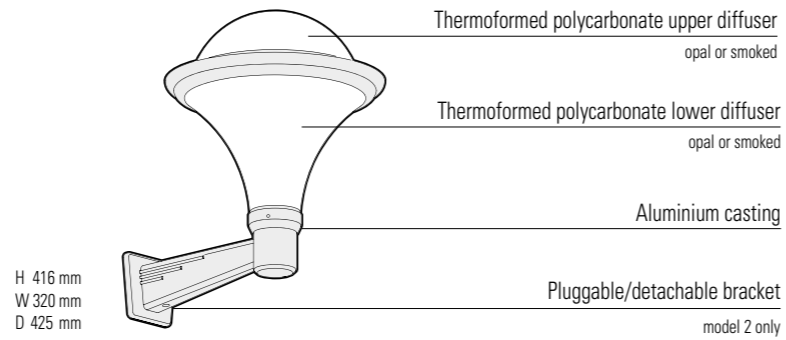

# Dallas

## REFERENCES

Replace ●●● with the colour code / replace (●) with the country's electrical socket code

MODELS	DIFFUSERS	E27	E27 + SENSOR	SOCKETS	CORNER PLATES
1	OPAL POLYCARBONATE	119 001 ●●●			147 003 ●●●
	SMOKED POLYCARBONATE	119 002 ●●●			
2	OPAL POLYCARBONATE	119 003 ●●●	119 004 ●●●		147 006 ●●●
	SMOKED POLYCARBONATE	119 005 ●●●	119 006 ●●●		
3	OPAL POLYCARBONATE	119 021 ●●●			147 001 ●●●
	SMOKED POLYCARBONATE	119 022 ●●●			
4	OPAL POLYCARBONATE	119 023 ●●●			147 001 ●●●
	SMOKED POLYCARBONATE	119 024 ●●●			
5	OPAL POLYCARBONATE	119 025 ●●●			
	SMOKED POLYCARBONATE	119 026 ●●●			
6	OPAL POLYCARBONATE	119 027 ●●●			
	SMOKED POLYCARBONATE	119 028 ●●●			
7	OPAL POLYCARBONATE	119 007 ●●●		119 008 ●●●(●)	
	SMOKED POLYCARBONATE	119 009 ●●●		119 010 ●●●(●)	
8	OPAL POLYCARBONATE	119 011 ●●●	119 013 ●●●	119 012 ●●●(●)	
	SMOKED POLYCARBONATE	119 014 ●●●	119 016 ●●●	119 015 ●●●(●)	
9	OPAL POLYCARBONATE	119 029 ●●●			
	SMOKED POLYCARBONATE	119 030 ●●●			
10	OPAL POLYCARBONATE	119 017 ●●●			
	SMOKED POLYCARBONATE	119 018 ●●●			
11	OPAL POLYCARBONATE	119 019 ●●●			
	SMOKED POLYCARBONATE	119 020 ●●●			

### SPARE UPPER DIFFUSERS

OPAL POLYCARBONATE	165 024 602
SMOKED POLYCARBONATE	165 024 603

### SPARE LOWER DIFFUSERS

OPAL POLYCARBONATE	165 073 602
SMOKED POLYCARBONATE	165 073 603

## COLOUR CODES

Replace ●●● with the colour code

	RAL 9005 JET BLACK 000		RAL 6009 BRITISH GREEN 019
	DARK GREY 006		RAL 6009 FIR GREEN 067
	SLATE GREY 059		RAL 5011 STEEL BLUE 065
	WHITE 001		RAL 5009 MATTE AZURE BLUE 134
	SANDSTONE 054	Other colours on request	

## SOCKET CODES

Except for French socket, replace (●) with country's socket code

	SCHUKO SOCKET SK		SWISS SOCKET CH
	type F		type J

## MOUNTING

Wiring entry points in grey  
Fixing kit included

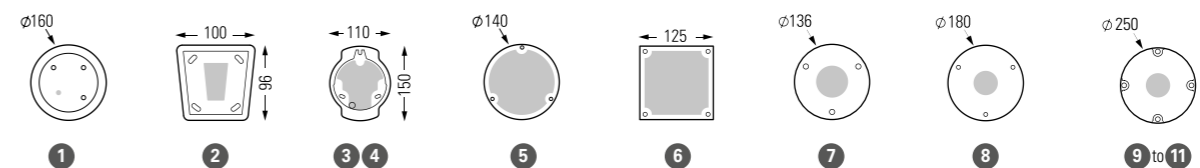



# Moon









# Moon

Aluminium  
Opal or smoked Ø200 mm PMMA globe (models 1 to 4)  
Opal Ø300 mm PMMA globe (models 5 to 13)  
IP44 / IK08 / Class 1

## SOURCES

E27 - 60W max (models 1 to 4)    Ø70 mm - H 150 mm max  
E27 - 105W max (models 5 to 13)    Ø80 mm - H 200 mm max

## MODELS Ø200 mm

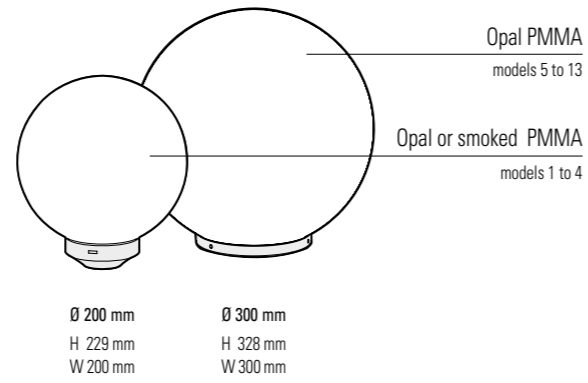
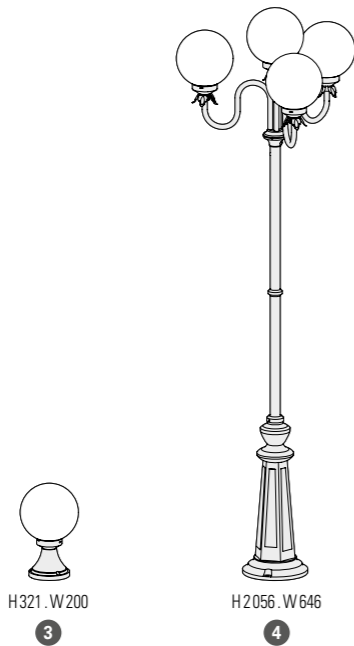
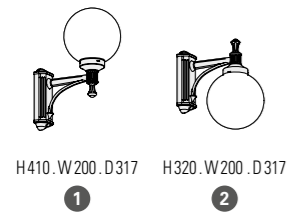

## MODELS Ø300 mm

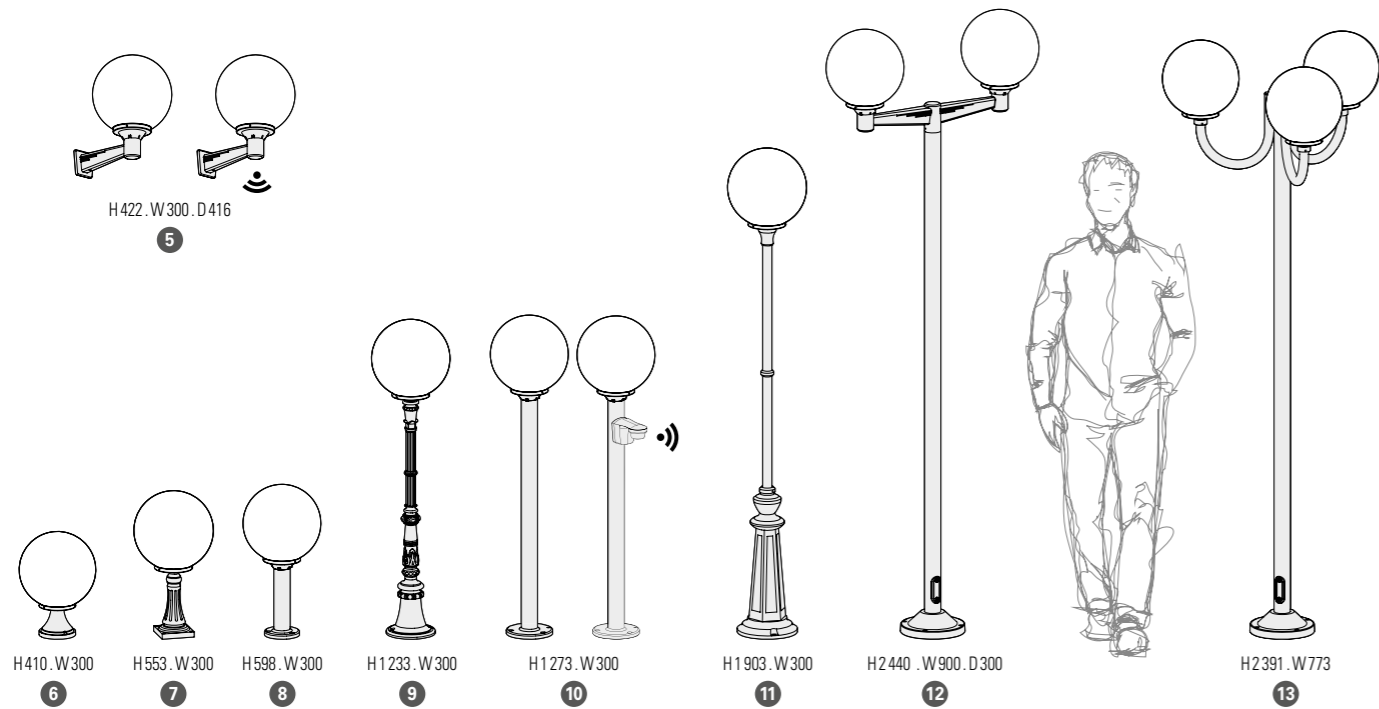

# Moon

## REFERENCES

Replace ... with the colour code

### Ø 200 mm

MODELS	GLOBES	E27	CORNER PLATES
1	SMOKED PMMA	109 001 ...	147 004 ...
	OPAL PMMA	109 002 ...	
2	SMOKED PMMA	109 003 ...	147 004 ...
	OPAL PMMA	109 004 ...	
3	SMOKED PMMA	109 007 ...	
	OPAL PMMA	109 008 ...	
4	SMOKED PMMA	109 011 ...	
	OPAL PMMA	109 012 ...	
SPARE GLOBES			
	SMOKED PMMA	165 015 607	
	OPAL PMMA	165 015 606	

### Ø 300 mm

MODELS	E27	E27 + SENSOR	CORNER PLATE
5	109 019 ...	109 020 ...	147 006 ...
6	109 013 ...		
7	109 014 ...		
8	109 017 ...		
9	109 016 ...		
10	109 021 ...	109 022 ...	
11	109 015 ...		
12	109 025 ...		
13	109 024 ...		
SPARE OPAL GLOBE			
		165 016 606	

## COLOUR CODES

Replace ... with the colour code

	RAL 9005 JET BLACK 000		SANDSTONE 054
	SLATE GREY 059		LIMESTONE 053
	GREEN PATINA 008		RAL 6009 BRITISH GREEN 019
	WHITE 001		RAL 6009 FIR GREEN 067

Other colours on request

## MOUNTING

Wiring entry points in grey  
Fixing kit included

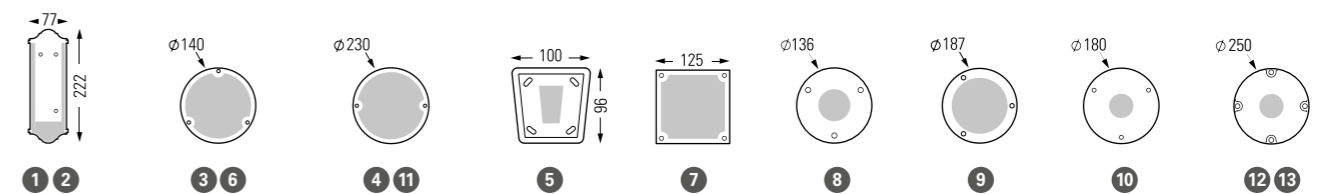

# Boréal





# Boréal

Aluminium  
Opal or smoked Ø200 mm PMMA globe  
IP44 / IK08 / Class 1

## SOURCE

E27 - 60W max Ø 70 mm - H 150 mm max

## MODELS

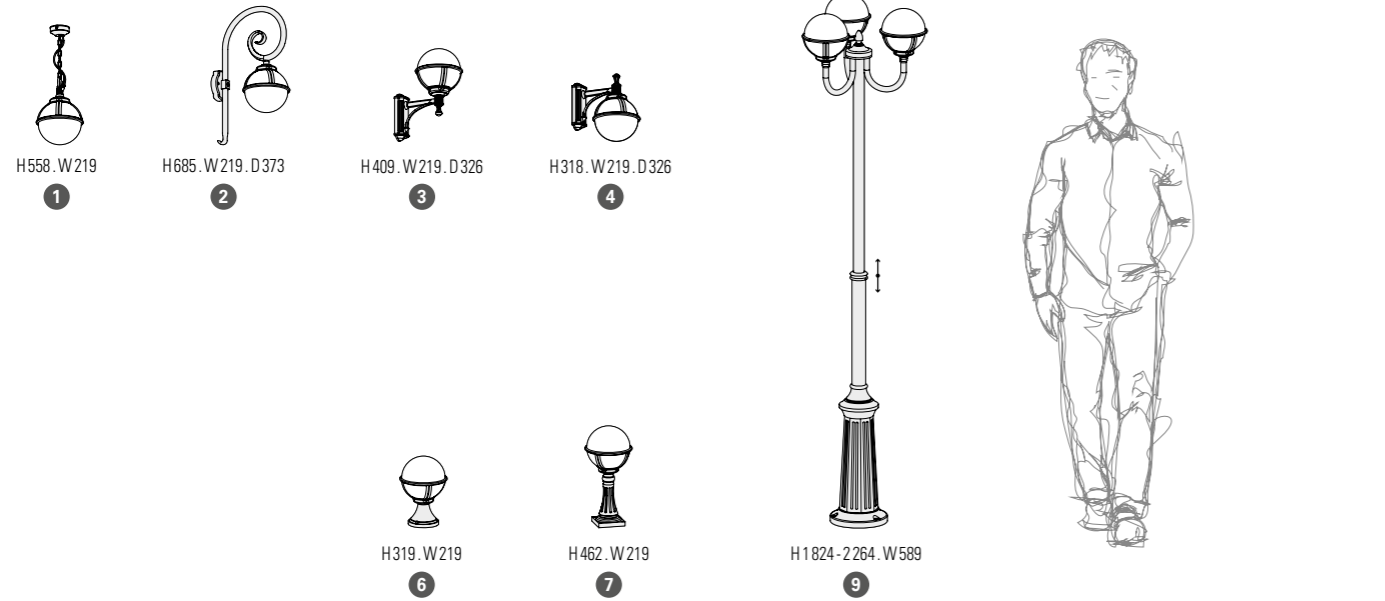

## REFERENCES

Replace ●●● with the colour code

MODELS	GLOBES	E27	CORNER PLATES
1	OPAL PMMA	111 001 ●●●	
	SMOKED PMMA	111 002 ●●●	
2	OPAL PMMA	111 003 ●●●	147 001 ●●●
	SMOKED PMMA	111 004 ●●●	
3	OPAL PMMA	111 005 ●●●	147 004 ●●●
	SMOKED PMMA	111 006 ●●●	
4	OPAL PMMA	111 007 ●●●	147 004 ●●●
	SMOKED PMMA	111 008 ●●●	
6	OPAL PMMA	111 009 ●●●	
	SMOKED PMMA	111 010 ●●●	
7	OPAL PMMA	111 011 ●●●	
	SMOKED PMMA	111 012 ●●●	
9	OPAL PMMA	111 015 ●●●	
	SMOKED PMMA	111 016 ●●●	
SPARE GLOBES			
	OPAL PMMA	165 015 606	
	SMOKED PMMA	165 015 607	

## MOUNTING

Wiring entry points in grey  
Fixing kit included

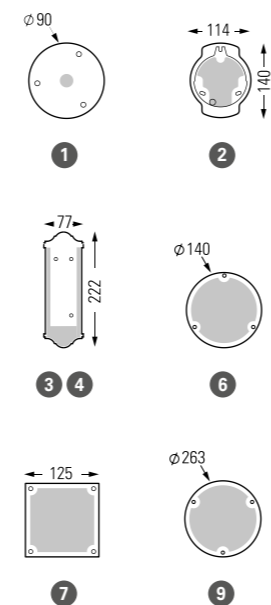

## COLOUR CODES

Replace ●●● with the colour code

	RAL 9005 JET BLACK 000		RAL 6009 BRITISH GREEN 019
	METAL GREY 023		RAL 6009 FIR GREEN 067
	WHITE 001		GREEN PATINA 008
	OLD RUSTIC 046		GOLD PATINA 009

Other colours on request



Duo

—





# Duo

Aluminium  
Clear tempered glass diffuser  
IP44 / Class 1

## SOURCE

GU10 PAR16 LED - 2x23W max H 80 mm max

## MODEL

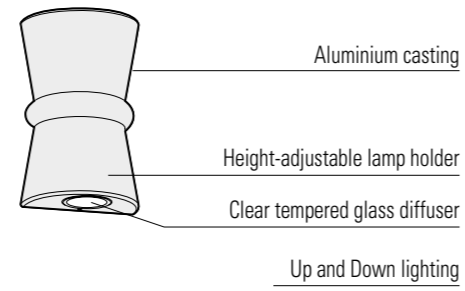
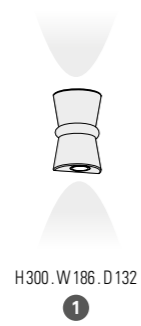

## REFERENCE

Replace ●●● with the colour code

MODEL	GU10 PAR16 LED
1	120 001 ●●●

## COLOUR CODES

Replace ●●● with the colour code

	DARK GREY 006		OLD RUSTIC 046
	SLATE GREY 059		SANDSTONE 054
	RAL 7044 SILK GREY 105		GOLD PATINA 009
	RAL 9010 PURE WHITE 101	Other colours on request	

## MOUNTING

Wiring entry point in grey  
Fixing kit included

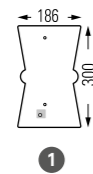



# Louis Philippe 1

---

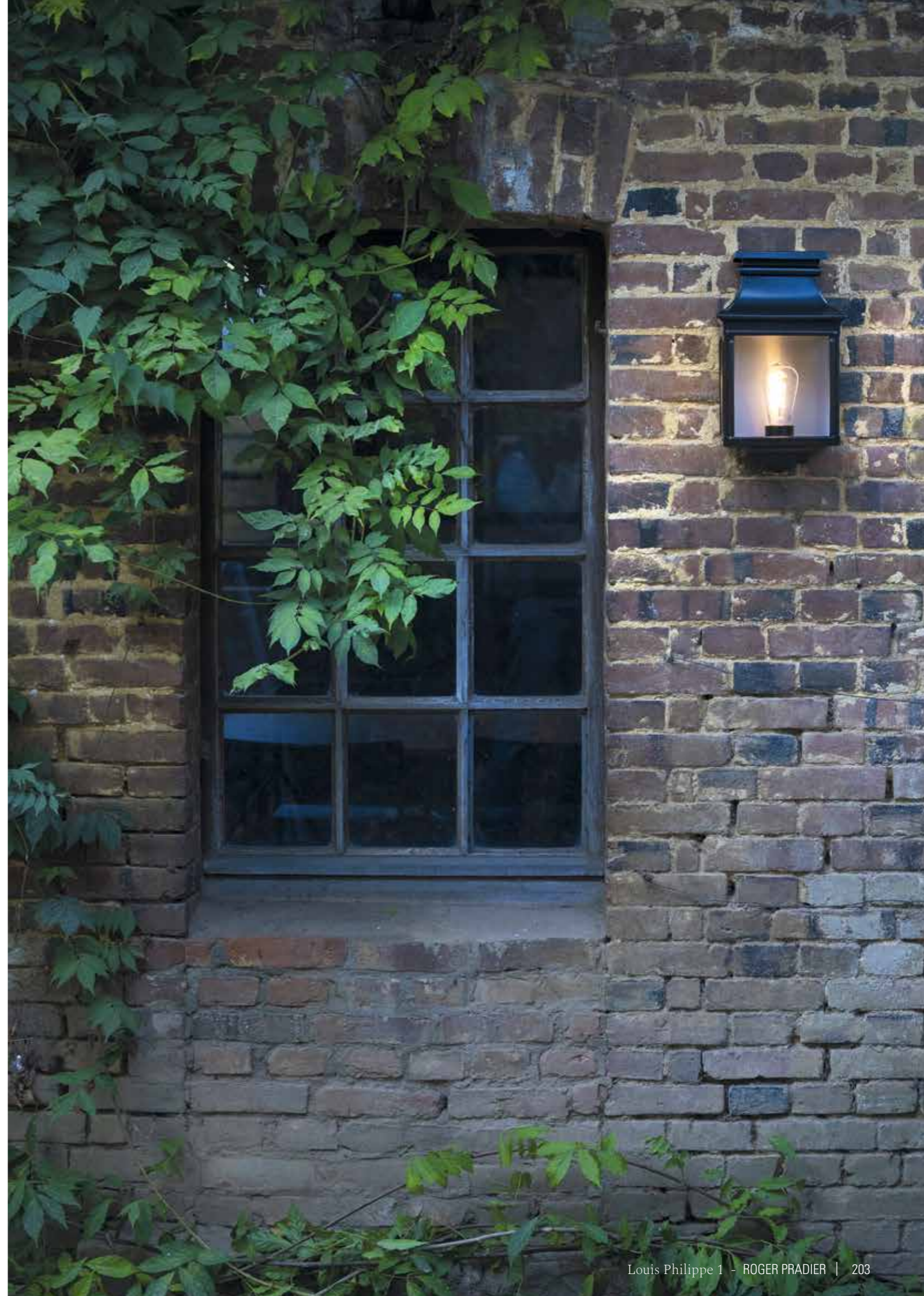



# Louis Philippe 1

Aluminium - Tinted Lacquered brass - Raw brass - Raw zinc  
 Clear glass diffuser  
 IP44 / Class 1

## SOURCE

E27 - 75W max    Ø 60 mm - H 200 mm max

## MODEL



H 366 mm  
 W 222 mm  
 D 132 mm

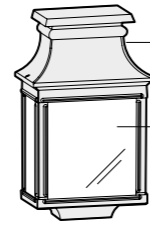

Assembly of spot-welded sheet metal

Clear glass diffuser

3-sided lighting



## REFERENCES

Replace ●●● with the colour code or the material code

MODEL	E27	SPARE DIFFUSER
1	134 001 ●●●	165 040 609

## COLOUR CODES

Replace ●●● with the colour code

	RAL 9005 JET BLACK 000		OLD RUSTIC 046
	SLATE GREY 059		GREEN PATINA 008
	WHITE 001		GOLD PATINA 009
	SANDSTONE 054	Other colours on request	

## MATERIAL CODES

Replace ●●● with the material code

	TINTED LACQUERED BRASS 070
	RAW BRASS 072 <i>See pages 12-13</i>
	RAW ZINC 092

## MOUNTING

Wiring entry point in grey  
 Fixing kit included

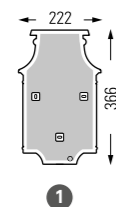

## Louis Philippe 2

---





# Louis Philippe 2

Aluminium - Tinted Lacquered brass - Raw zinc  
 Clear glass diffuser  
 IP44 / Class 1

## SOURCES

E27 - 2 x 105W max    Ø40 mm - H 130 mm max  
 G9 LED - 2 x 9W max

## MODEL



H 427. W 279. D 188

1



H 427 mm  
 W 279 mm  
 D 188 mm

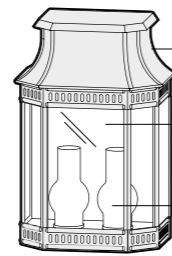

Assembly of spot-welded sheet metal

Removable clear glass diffuser  
 for easy relamping

2 frosted glass bulb covers

## REFERENCES

Replace ●●● with the colour code or the material code

MODEL	E27	G9 LED
1	135 001 ●●●	135 002 ●●●

### SPARE DIFFUSERS

SPARE SET OF CLEAR GLASS	165 041 609
SPARE FROSTED GLASS BULB COVER	165 076 610

## COLOUR CODES

Replace ●●● with the colour code

	RAL 9005 JET BLACK 000		OLD RUSTIC 046
	SLATE GREY 059		RAL 6009 FIR GREEN 067
	WHITE 001		GREEN PATINA 008
	SANDSTONE 054		GOLD PATINA 009

Other colours on request

## MATERIAL CODES

Replace ●●● with the material code

	TINTED LACQUERED BRASS 070
	RAW ZINC 092

## MOUNTING

Wiring entry point in grey  
 Fixing kit included

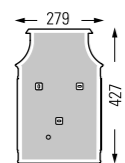

1



Tinted lacquered brass 070



Raw zinc 092





# Louis Philippe 7

Design Stéphane Joyeux

---





# Louis Philippe 7

Aluminium  
Clear glass or Opal polycarbonate diffuser  
IP44 / Class 2

## SOURCES

E27 - 23W max Ø 40 mm - H 160 mm max  
G9 LED - 9W max

## MODEL

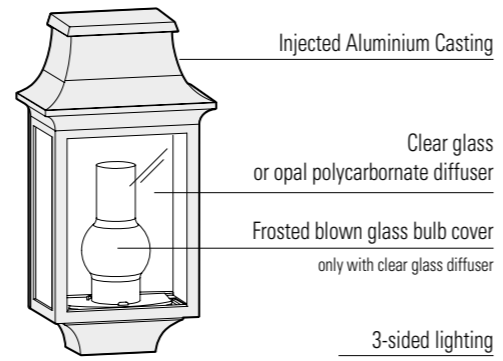
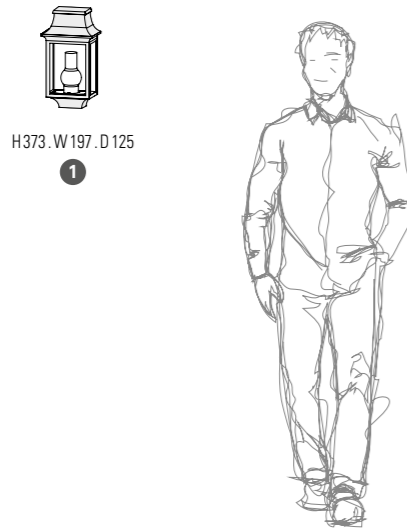

## REFERENCES

Replace ●●● with the colour code

MODEL	E27	G9 LED
1 CLEAR GLASS	136 001 ●●●	136 002 ●●●
OPAL POLYCARBONATE	136 003 ●●●	136 004 ●●●
SPARE DIFFUSERS		
SPARE SET OF CLEAR GLASS	165 042 609	
OPAL POLYCARBONATE	165 042 602	
SPARE FROSTED GLASS BULB COVER	165 076 610	

## COLOUR CODES

Replace ●●● with the colour code

	RAL 9005 JET BLACK 000		OLD RUSTIC 046
	SLATE GREY 059		GREEN PATINA 008
	WHITE 001		GOLD PATINA 009
	SANDSTONE 054	Other colours on request	

## MOUNTING

Wiring entry point in grey  
Fixing kit included

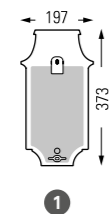



# Vieille France

---

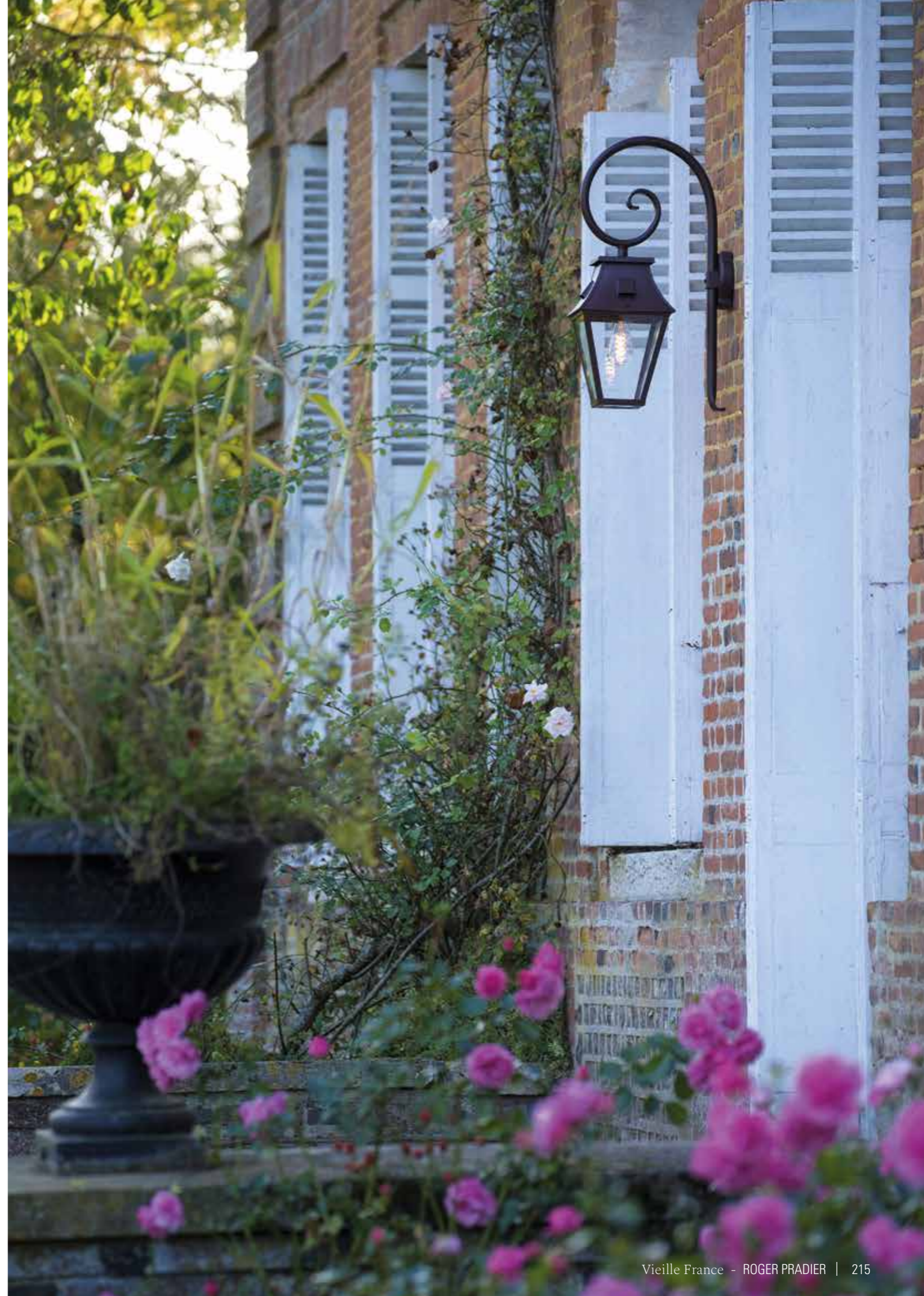



# Vieille France

Aluminium - Tinted Lacquered brass - Raw brass - Raw zinc (model 2)  
 Clear glass diffuser  
 IP44 / Class 1

## SOURCES

E27 - 105W max (except model 2) H 200 mm max  
 E27 - 75W max (model 2) Ø66 mm - H 120 mm max

## MODELS

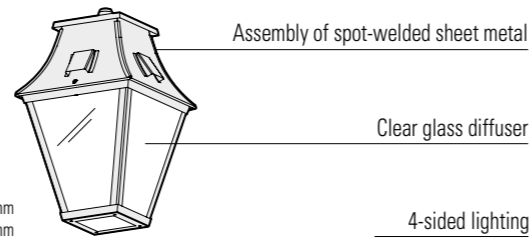
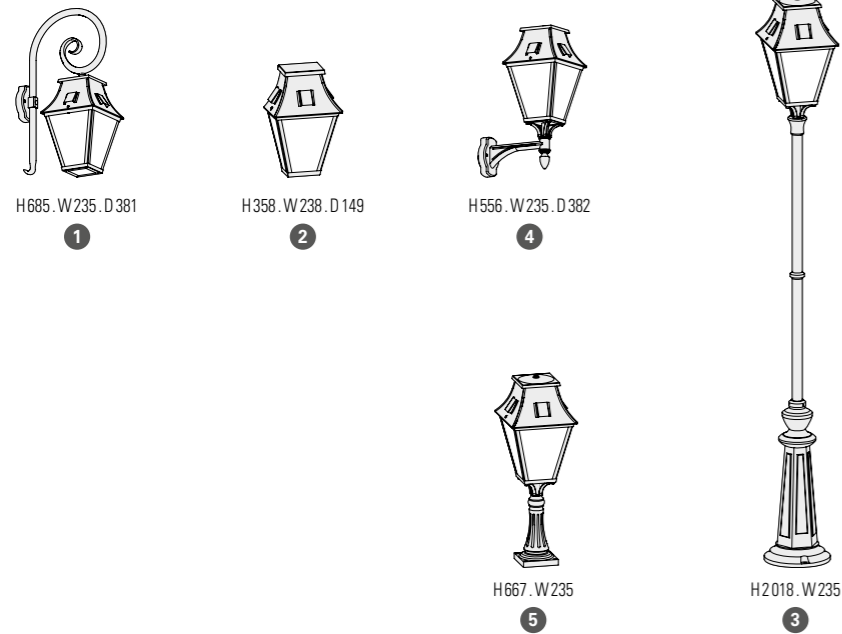

## REFERENCES

Replace ●●● with the colour code or the material code

MODELS	E27	CORNER PLATE
1	163 001 ●●●	147 001 ●●●
2	163 002 ●●●	
3	163 003 ●●●	
4	163 004 ●●●	147 001 ●●●
5	163 005 ●●●	
SPARE DIFFUSERS		
	165 067 609 (model 2)	
	165 068 609	

## MOUNTING

Wiring entry points in grey  
 Fixing kit included

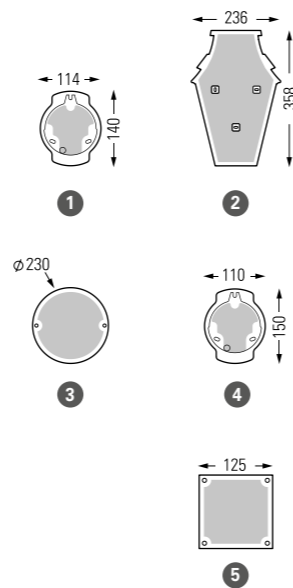

## COLOUR CODES

Replace ●●● with the colour code

	RAL 9005 JET BLACK	000
	OLD RUSTIC	046
	SANDSTONE	054
	GREEN PATINA	008

Other colours on request

## MATERIAL CODES

Replace ●●● with the material code

	TINTED LACQUERED BRASS	070
	RAW BRASS	072
	RAW ZINC	092 (model 2)

Aluminium base Jet black 000 RAL 9005





# Louvre

---







Lacquered patinated copper 080



Raw copper 082



Lacquered patinated copper 080





# Louvre

Aluminium - Lacquered patinated copper - Raw copper  
 Golden crown and pine cone (for all references)  
 Single-colour including crown and pine cone (on request)  
 Clear glass diffuser / Opal glass diffuser (on request)  
 IP44 / IP65 lantern - on request (except model 4) / Class 1

## SOURCES

LED 10W - 2700K warm white (model 4 only)  
 LED 13W - 2700K warm white  
 E27 - 105W max H200 mm max (except model 4)  
 Ø60 mm - H200 mm max (model 4)

PRM Average Illuminance 20 lux p.300  
 Model 2

LED 13W	Pathway	Spacing
H 2,00m	2,00m	6,00m

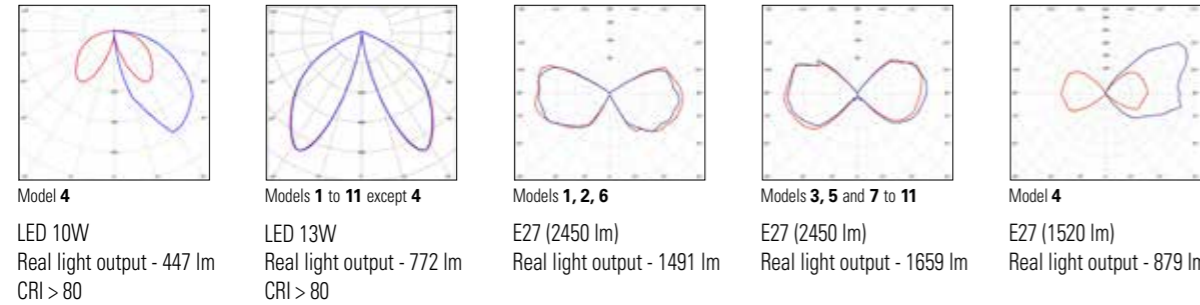

## MODELS

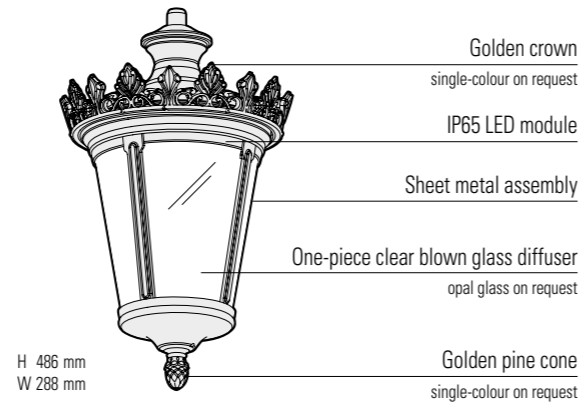
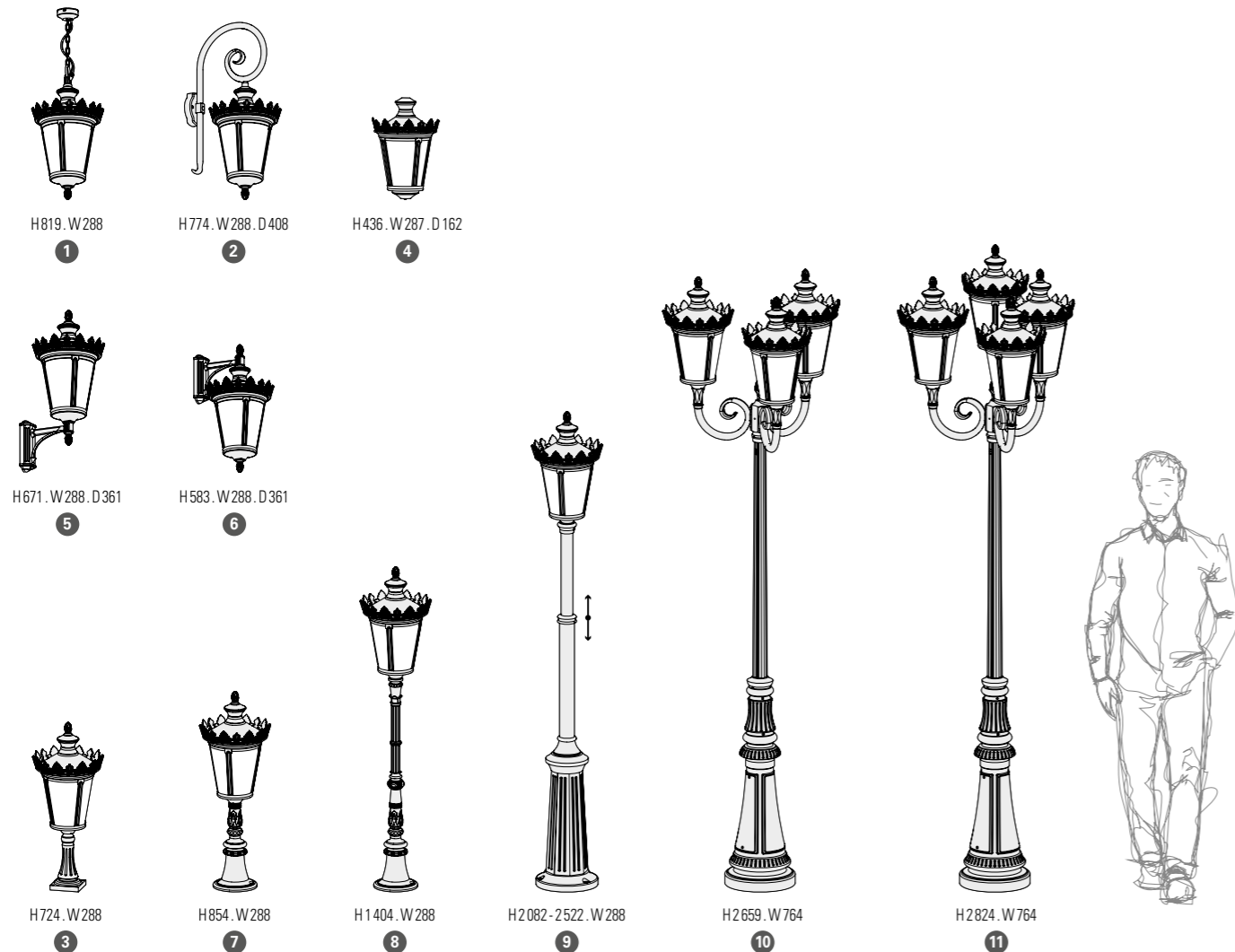

## REFERENCES

Replace ... with the colour code or the material code

MODELS	E27	LED 10W 2700K warm white	LED 13W 2700K warm white	CORNER PLATES	SPARE DIFFUSERS
1	133 001 ...		133 102 ...		165 038 609
2	133 003 ...		133 104 ...	147 001 ...	165 038 609
3	133 005 ...		133 106 ...		E27 165 038 609 LED 165 039 609
4	133 007 ...	133 108 ...			165 037 609
5	133 009 ...		133 110 ...	147 004 ...	E27 165 038 609 LED 165 039 609
6	133 011 ...		133 112 ...	147 004 ...	165 038 609
7	133 013 ...		133 114 ...		E27 165 038 609 LED 165 039 609
8	133 015 ...		133 116 ...		E27 165 038 609 LED 165 039 609
9	133 017 ...		133 118 ...		E27 165 038 609 LED 165 039 609
10	133 019 ...		133 120 ...		E27 165 038 609 LED 165 039 609
11	133 021 ...		133 122 ...		E27 165 038 609 LED 165 039 609

**Golden crown and pine cone**  
(for all references)

**Single-colour**  
including crown and pine cone  
(on request)

## COLOUR CODES

Replace ... with the colour code

	RAL 9005 JET BLACK	000
	RAL 7044 SILK GREY	105
	RAL 3005 WINE RED	066
	RAL 6009 BRITISH GREEN	019
	RAL 6009 FIR GREEN	067
	GOLD PATINA	009

With Golden crown and pine cone  
 Other colours on request

## MATERIAL CODES

Replace ... with the material code

	LACQUERED PATINATED COPPER	080
	RAW COPPER	082

See pages 12-13

With Aluminium base Jet black 000 (RAL 9005)  
 With Golden crown and pine cone

## MOUNTING

Wiring entry points in grey  
 Fixing kit included (except models 10 and 11)  
 Anchor bolts on request (models 10 and 11) p.302

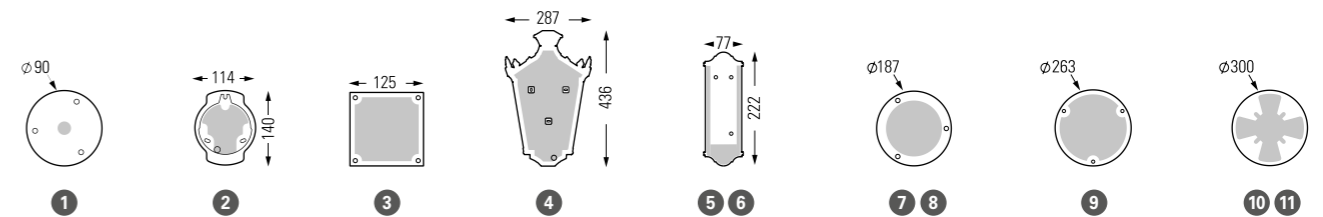



# Chenonceau

Design Stéphane Joyeux

---





# Chenonceau

Aluminium  
Clear glass diffuser  
IP44 / Class 1

## SOURCE

E27 - 75W max H 160 mm max

## MODELS

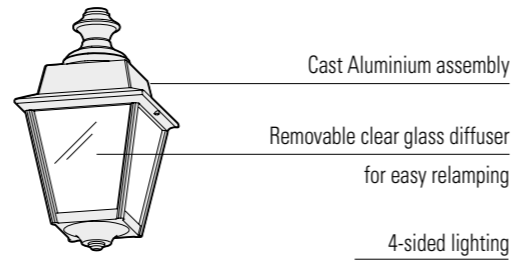

H 627 . W 165  
**1**



H 384 . W 165 . D 236  
**2**



H 518 . W 165 . D 317  
**3**



H 354 . W 165 . D 306  
**4**

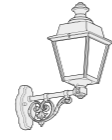

H 410 . W 165 . D 306  
**5**

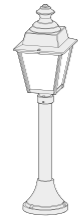

H 657 . W 165  
**6**



H 531 . W 165  
**7**



H 388 . W 165  
**8**



## REFERENCES

Replace **•••** with the colour code

MODELS	E27	CORNER PLATE
<b>1</b>	117 001 •••	
<b>2</b>	117 002 •••	147 002 •••
<b>3</b>	117 003 •••	147 002 •••
<b>4</b>	117 004 •••	147 002 •••
<b>5</b>	117 005 •••	147 002 •••
<b>6</b>	117 006 •••	
<b>7</b>	117 007 •••	
<b>8</b>	117 008 •••	
SPARE DIFFUSER		
	165 022 609	

## COLOUR CODES

Replace **•••** with the colour code

	RAL 9005 JET BLACK <b>000</b>		RAL 6009 BRITISH GREEN <b>019</b>
	SLATE GREY <b>059</b>		RAL 6009 FIR GREEN <b>067</b>
	WHITE <b>001</b>		GREEN PATINA <b>008</b>
	OLD RUSTIC <b>046</b>		GOLD PATINA <b>009</b>
	SANDSTONE <b>054</b>	Other colours on request	

## MOUNTING

Wiring entry points in grey  
Fixing kit included

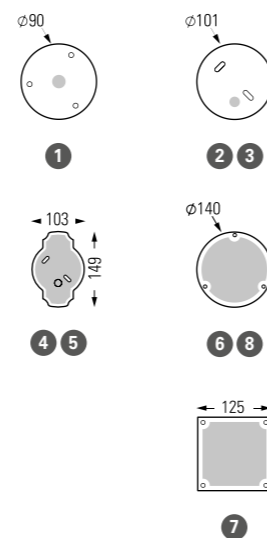



## Place des Vosges 1 Tradition

---



Place des Vosges 1  
Tradition



Place des Vosges 1  
Évolution

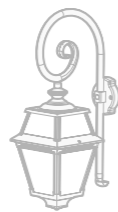

Place des Vosges 2

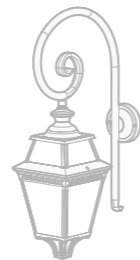

Place des Vosges 3





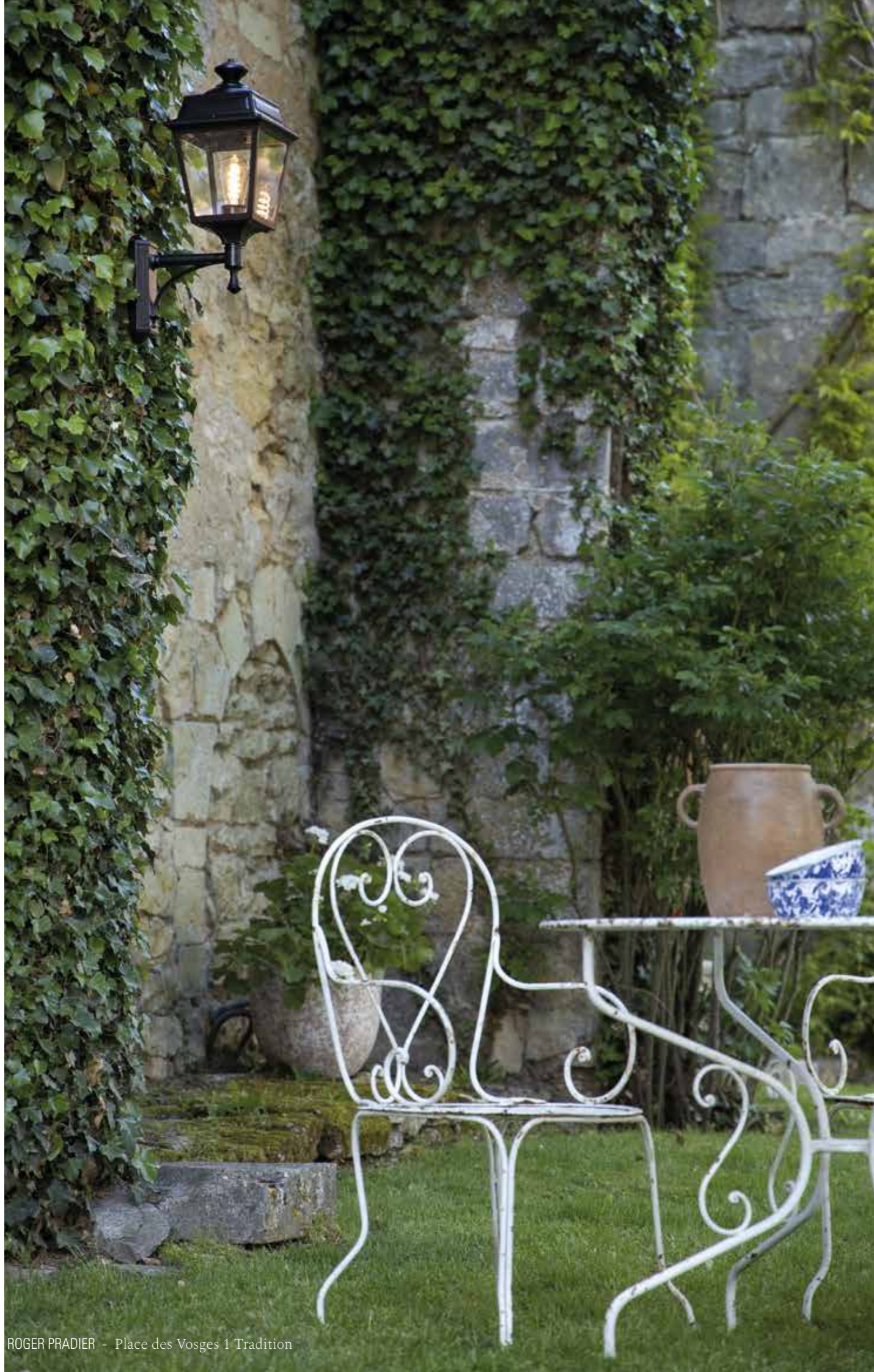

Raw brass 072



Tinted lacquered brass 070





# Place des Vosges 1 Tradition

Aluminium - Tinted Lacquered brass - Raw brass  
Clear or frosted glass diffuser  
IP44 / Class 1

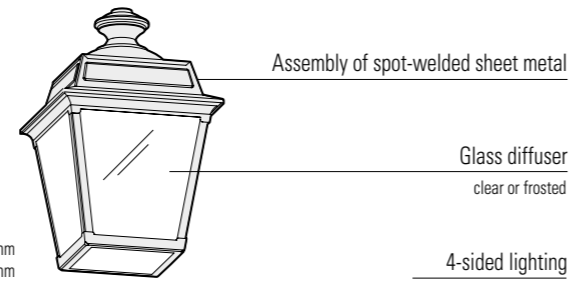

H 329 mm  
W 214 mm

PRM Average Illuminance 20 lux p.300  
Models 4 and 5

E27 (2450 lm)	Pathway	Spacing
H 2,00m	2,00 m	2,50 m

## SOURCE

E27 - 105W max H 160 mm max (except model 2)  
Ø 63 mm - H 160 mm max (model 2)

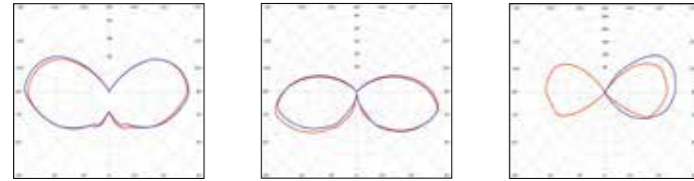

Models 1, 4, 5 E27 (2450 lm) Real light output - 1455 lm  
Models 3 and 6 to 13 E27 (2450 lm) Real light output - 1098 lm  
Model 2 E27 (1520 lm) Real light output - 921 lm

## MODELS



H664. W214  
H360. W214. D125  
H562. W214. D324

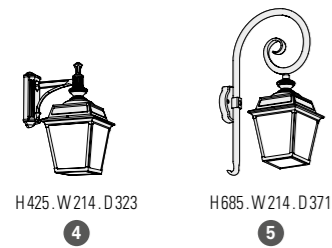

H425. W214. D323  
H685. W214. D371

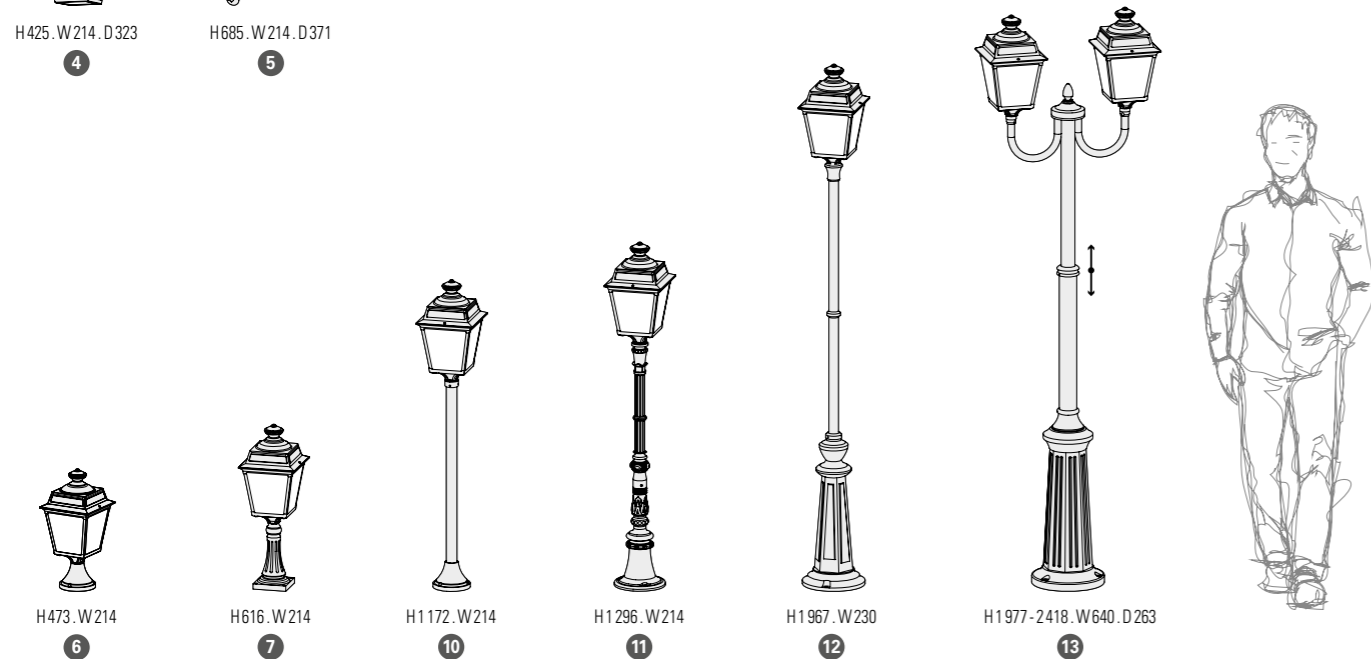

H473. W214  
H616. W214  
H1172. W214  
H1296. W214  
H1967. W230  
H1977-2418. W640. D263

# Place des Vosges 1 Tradition

## REFERENCES

Replace ... with the colour code or the material code

MODELS	DIFFUSERS	E27	CORNER PLATES
1	CLEAR GLASS	151 001 ...	
	FROSTED GLASS	151 002 ...	
2	CLEAR GLASS	151 003 ...	
	FROSTED GLASS	151 004 ...	
3	CLEAR GLASS	151 005 ...	147 004 ...
	FROSTED GLASS	151 006 ...	
4	CLEAR GLASS	151 007 ...	147 004 ...
	FROSTED GLASS	151 008 ...	
5	CLEAR GLASS	151 009 ...	147 001 ...
	FROSTED GLASS	151 010 ...	
6	CLEAR GLASS	151 011 ...	
	FROSTED GLASS	151 012 ...	
7	CLEAR GLASS	151 013 ...	
	FROSTED GLASS	151 014 ...	
10	CLEAR GLASS	151 015 ...	
	FROSTED GLASS	151 016 ...	
11	CLEAR GLASS	151 017 ...	
	FROSTED GLASS	151 018 ...	
12	CLEAR GLASS	151 019 ...	
	FROSTED GLASS	151 020 ...	
13	CLEAR GLASS	151 021 ...	
	FROSTED GLASS	151 022 ...	

### SPARE DIFFUSERS

CLEAR GLASS (model 2)	165 057 609
FROSTED GLASS (model 2)	165 057 610
CLEAR GLASS	165 058 609
FROSTED GLASS	165 058 610

## COLOUR CODES

Replace ... with the colour code

	RAL 9005 JET BLACK	000
	SLATE GREY	059
	WHITE	001
	OLD RUSTIC	046
	SANDSTONE	054
	RAL 6009 BRITISH GREEN	019
	RAL 6009 FIR GREEN	067
	GREEN PATINA	008
	GOLD PATINA	009

Other colours on request

## MATERIAL CODES

Replace ... with the material code

	TINTED LACQUERED BRASS	070
	RAW BRASS	072 See pages 12-13

With Aluminium base Jet black 000 (RAL 9005)

## MOUNTING

Wiring entry points in grey  
Fixing kit included

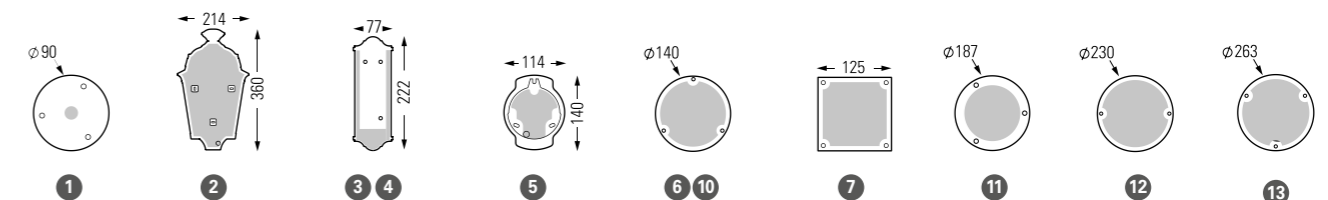



# Place des Vosges 1 Évolution

Design Stéphane Joyeux



Place des Vosges 1  
Tradition

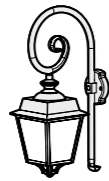

Place des Vosges 1  
Évolution

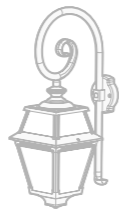

Place des Vosges 2

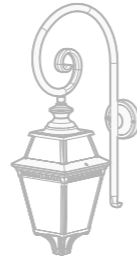

Place des Vosges 3









# Place des Vosges 1 Évolution

Aluminium  
Clear or opal PMMA diffuser  
IP65 (lantern) / Class 1

## SOURCES

E27 - 60W max (except model 2) H 160 mm max  
E27 - 23W max (model 2) Ø 66 mm - H 150 mm max  
GU10 PAR16 LED - 9W max (model 2) H 60 mm max

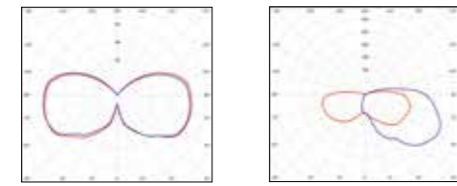

Models 1 to 13 except 2 E27 (2450 lm)  
Real light output - 1348 lm  
Model 2 E27 (1520 lm)  
Real light output - 874 lm

## MODELS

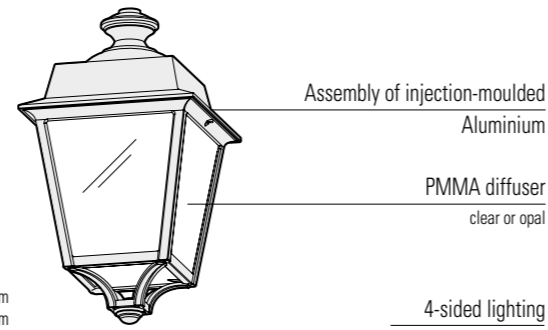
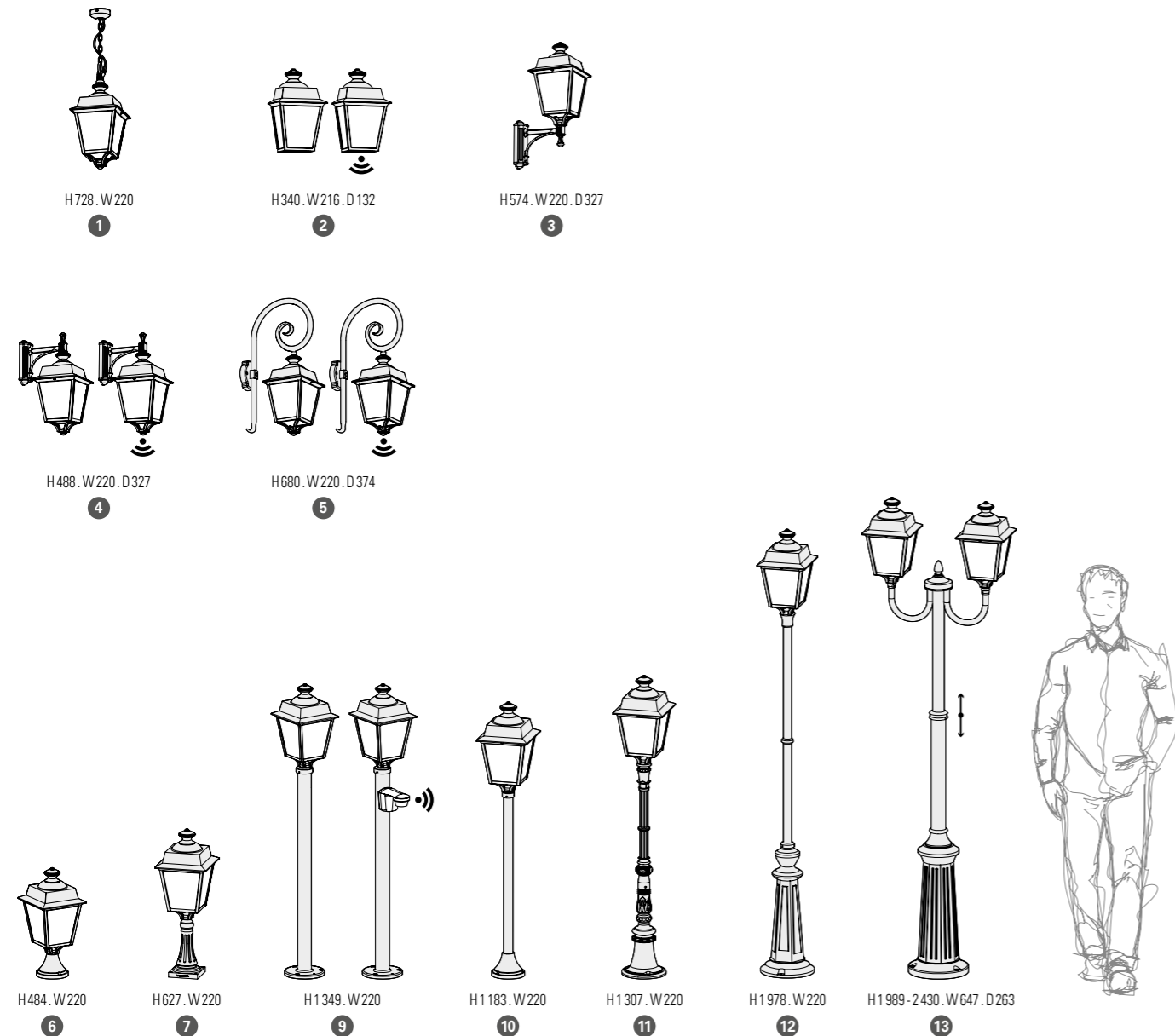

PRM Average Illuminance 20 lux p.300  
Models 4 and 5

E27 (2450 lm)	Pathway	Spacing
H 2,00m	2,00m	2,50m

# Place des Vosges 1 Évolution

## REFERENCES

Replace ●●● with the colour code

MODELS	DIFFUSERS	E27	GU10 PAR16 LED	E27 + SENSOR	CORNER PLATES
1	CLEAR PMMA	150 001 ●●●			
	OPAL PMMA	150 002 ●●●			
2	CLEAR PMMA	150 003 ●●●	150 005 ●●●	150 004 ●●●	
	OPAL PMMA	150 006 ●●●	150 008 ●●●	150 007 ●●●	
3	CLEAR PMMA	150 009 ●●●			147 004 ●●●
	OPAL PMMA	150 010 ●●●			
4	CLEAR PMMA	150 011 ●●●		150 012 ●●●	147 004 ●●●
	OPAL PMMA	150 013 ●●●		150 014 ●●●	
5	CLEAR PMMA	150 015 ●●●		150 016 ●●●	147 001 ●●●
	OPAL PMMA	150 017 ●●●		150 018 ●●●	
6	CLEAR PMMA	150 019 ●●●			
	OPAL PMMA	150 020 ●●●			
7	CLEAR PMMA	150 021 ●●●			
	OPAL PMMA	150 022 ●●●			
9	CLEAR PMMA	150 023 ●●●		150 024 ●●●	
	OPAL PMMA	150 025 ●●●		150 026 ●●●	
10	CLEAR PMMA	150 027 ●●●			
	OPAL PMMA	150 028 ●●●			
11	CLEAR PMMA	150 029 ●●●			
	OPAL PMMA	150 030 ●●●			
12	CLEAR PMMA	150 031 ●●●			
	OPAL PMMA	150 032 ●●●			
13	CLEAR PMMA	150 033 ●●●			
	OPAL PMMA	150 034 ●●●			

### SPARE DIFFUSERS

CLEAR PMMA	165 056 605
OPAL PMMA	165 056 606
CLEAR PMMA (model 2)	165 055 605
OPAL PMMA (model 2)	165 055 606
CLEAR PMMA (model 2)	☺ 165 074 605
OPAL PMMA (model 2)	☺ 165 074 606

## COLOUR CODES

Replace ●●● with the colour code ↴

	RAL 9005 JET BLACK 000		RAL 6009 BRITISH GREEN 019
	SLATE GREY 059		RAL 6009 FIR GREEN 067
	WHITE 001		GREEN PATINA 008
	OLD RUSTIC 046		GOLD PATINA 009
	SANDSTONE 054	Other colours on request	

## MOUNTING

Wiring entry points in grey  
Fixing kit included

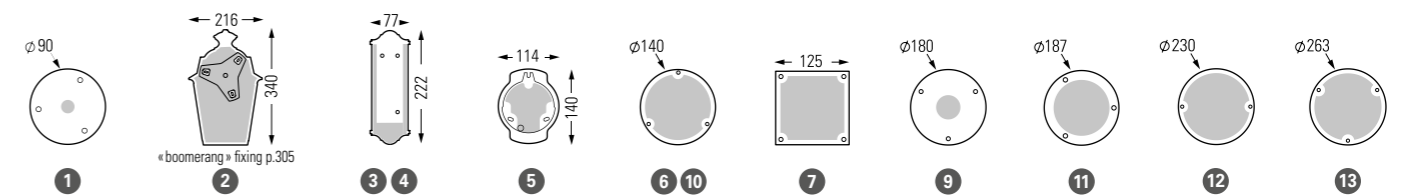



# Place des Vosges 2



Place des Vosges 1  
Tradition



Place des Vosges 1  
Évolution

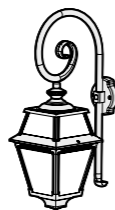

Place des Vosges 2

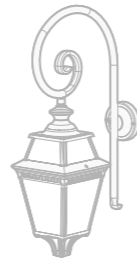

Place des Vosges 3









# Place des Vosges 2

Aluminium - Tinted Lacquered brass - Raw brass  
Clear glass diffuser  
IP44 / Class 1

## SOURCE

E27 - 105W max H200 mm max (except model 3)  
Ø66 mm - H200 mm max (model 3)

## MODELS

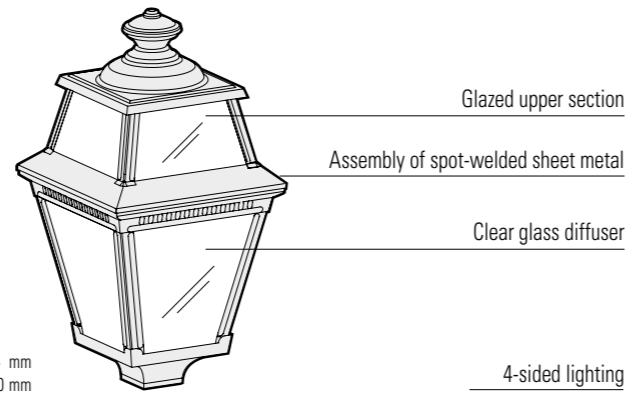

H789 . W240  
1



H742 . W240 . D384  
2



H436 . W240 . D131  
3



H640 . W240 . D337  
4



H549 . W240 . D337  
5



H550 . W240  
6



H693 . W240  
7

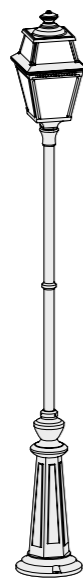

H2044 . W240  
8

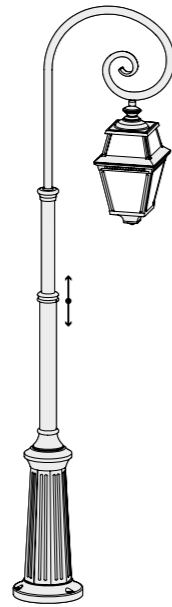

H2332-2773 . W263 . D626  
9

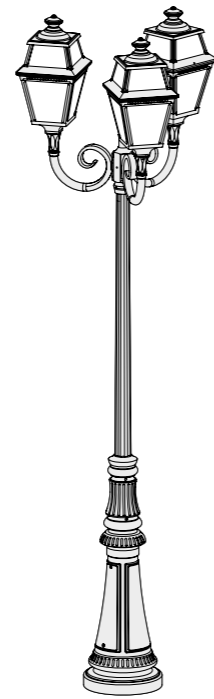

H2617 . W797  
11



## REFERENCES

Replace **...** with the colour code or the material code

MODELS	E27	CORNER PLATES
1	148 001 <b>...</b>	
2	148 002 <b>...</b>	147 001 <b>...</b>
3	148 003 <b>...</b>	
4	148 004 <b>...</b>	147 004 <b>...</b>
5	148 005 <b>...</b>	147 004 <b>...</b>
6	148 006 <b>...</b>	
7	148 007 <b>...</b>	
8	148 008 <b>...</b>	
9	148 009 <b>...</b>	
11	148 010 <b>...</b>	
SPARE DIFFUSERS		
165 052 609		
165 051 609 (Model 3)		

## COLOUR CODES

Replace **...** with the colour code

	RAL 9005 JET BLACK	000
	WHITE	001
	OLD RUSTIC	046
	GREEN PATINA	008
	GOLD PATINA	009

Other colours on request

## MATERIAL CODES

Replace **...** with the material code

	TINTED LACQUERED BRASS	070
	RAW BRASS	072 <i>See pages 12-13</i>

With Aluminium base Jet black 000 (RAL 9005)

## MOUNTING

Wiring entry points in grey  
Fixing kit included (except model 11)  
Anchor bolts on request (model 11) p.302

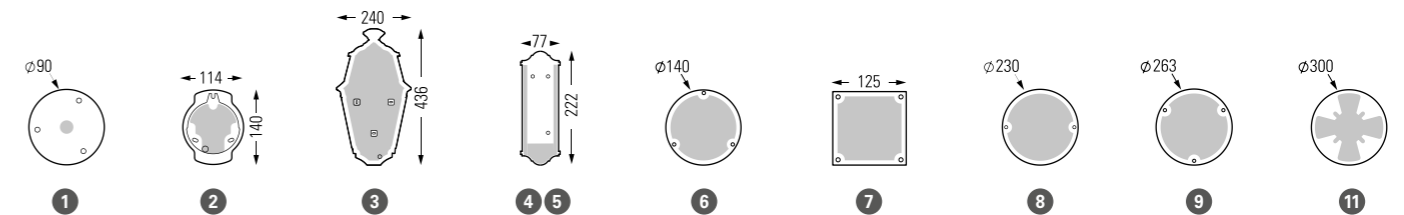



# Place des Vosges 3



Place des Vosges 1  
Tradition



Place des Vosges 1  
Évolution

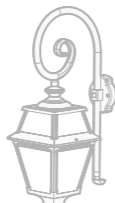

Place des Vosges 2

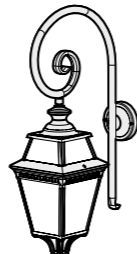

Place des Vosges 3









# Place des Vosges 3

Aluminium - Tinted Lacquered brass - Raw brass  
Clear glass diffuser  
IP44 / Class 1

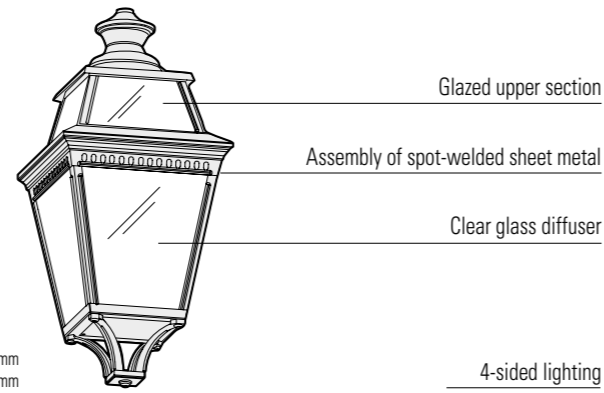

## SOURCE

E27 - 105W max H 220 mm max (except model 2)  
Ø 66 mm - H 200 mm max (model 2)

## MODELS

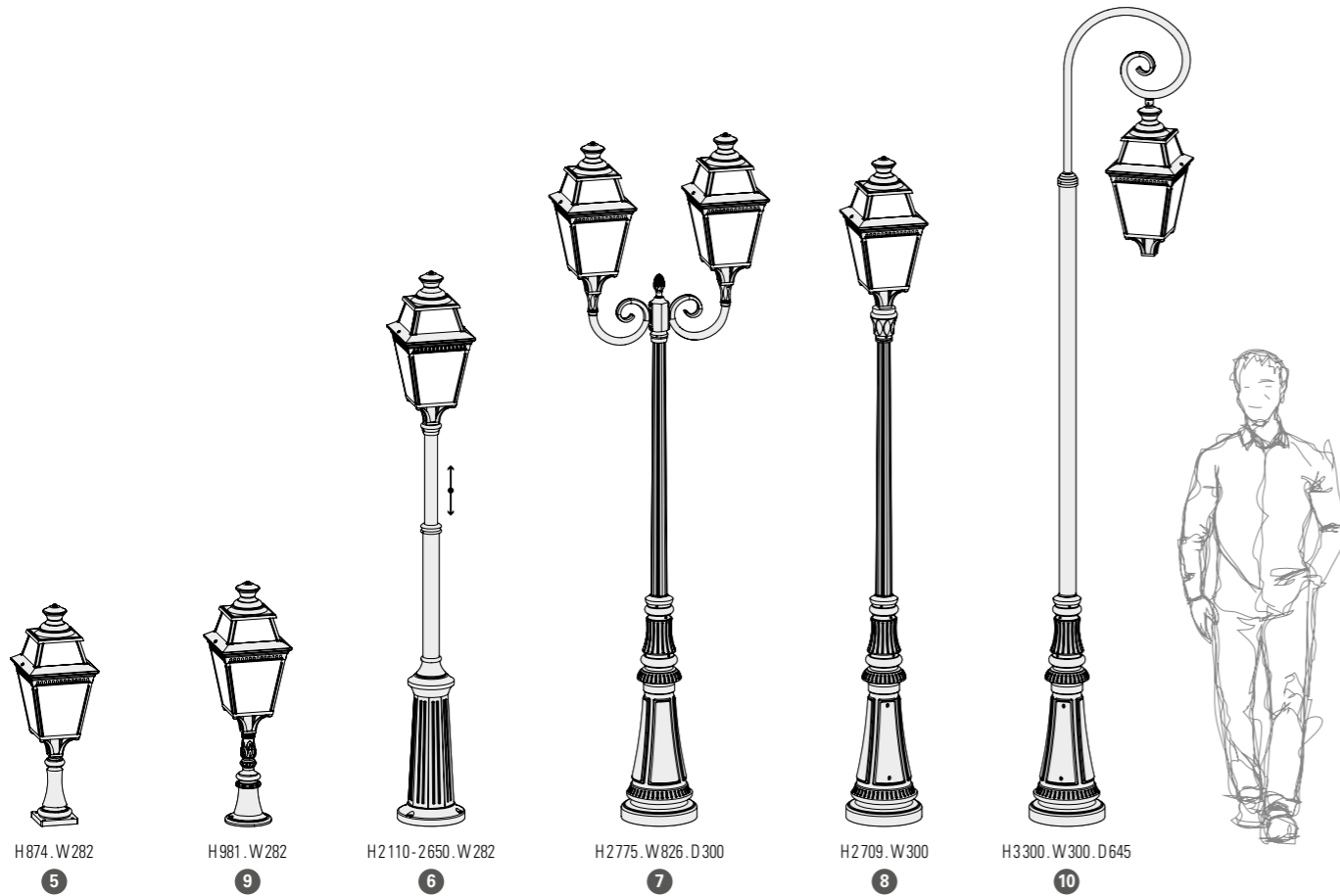

# Place des Vosges 3

## REFERENCES

Replace ... with the colour code or the material code

MODELS	E27	CORNER PLATES
1	149 001 ...	
2	149 002 ...	
3	149 003 ...	147 003 ...
4	149 004 ...	147 001 ...
5	149 005 ...	
6	149 006 ...	
7	149 007 ...	
8	149 008 ...	
9	149 009 ...	
10	149 010 ...	

### SPARE DIFFUSERS

165 054 609  
165 053 609 (model 2)

## COLOUR CODES

Replace ... with the colour code

	RAL 9005 JET BLACK	000
	WHITE	001
	OLD RUSTIC	046
	GREEN PATINA	008
	GOLD PATINA	009

Other colours on request

## MATERIAL CODES

Replace ... with the material code

	TINTED LACQUERED BRASS	070
	RAW BRASS	072

With Aluminium base Jet black 000 (RAL 9005) *See pages 12-13*

## MOUNTING

Wiring entry points in grey  
Fixing kit included (except models 7, 8, 10)  
Anchor bolts on request (models 7, 8, 10) p.302

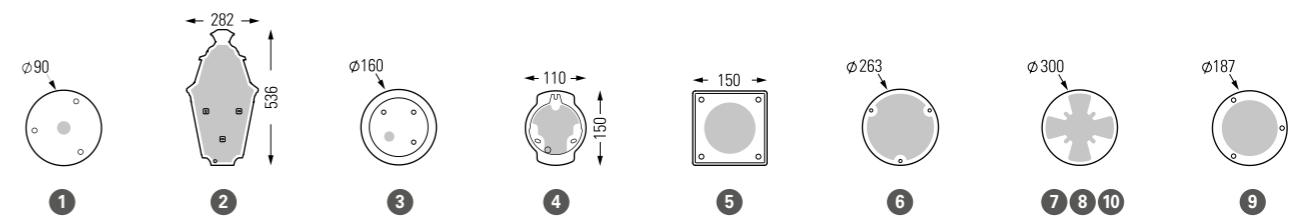



## Avenue 2

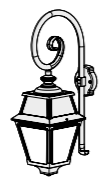

Avenue 2

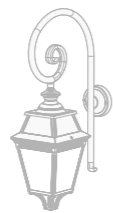

Avenue 3

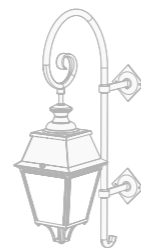

Avenue 4









# Avenue 2

Aluminium - Tinted Lacquered brass - Raw brass  
Clear glass or opal PMMA diffuser  
IP44 / Class 1

## SOURCES

LED 10W - 2700K warm white  
LED 13W - 2700K warm white  
E27 - 105W max H200 mm max (except model 3)  
Ø66 mm - H200 mm max (model 3)

PRM Average Illuminance 20 lux p.300  
Models 2 and 4

LED 13W	Pathway	Spacing
H 2,00m	2,00m	6,00m

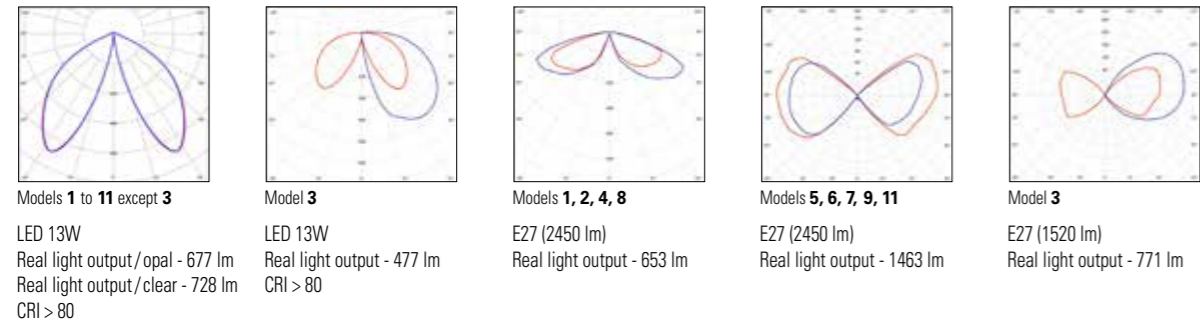

## MODELS

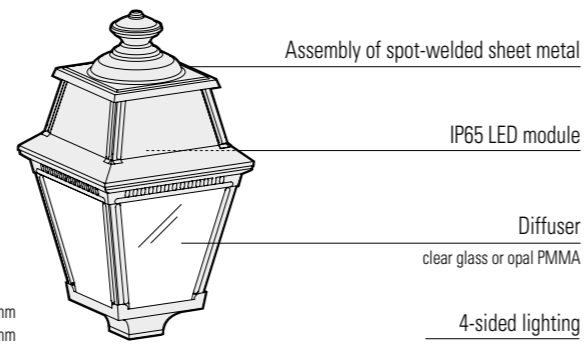
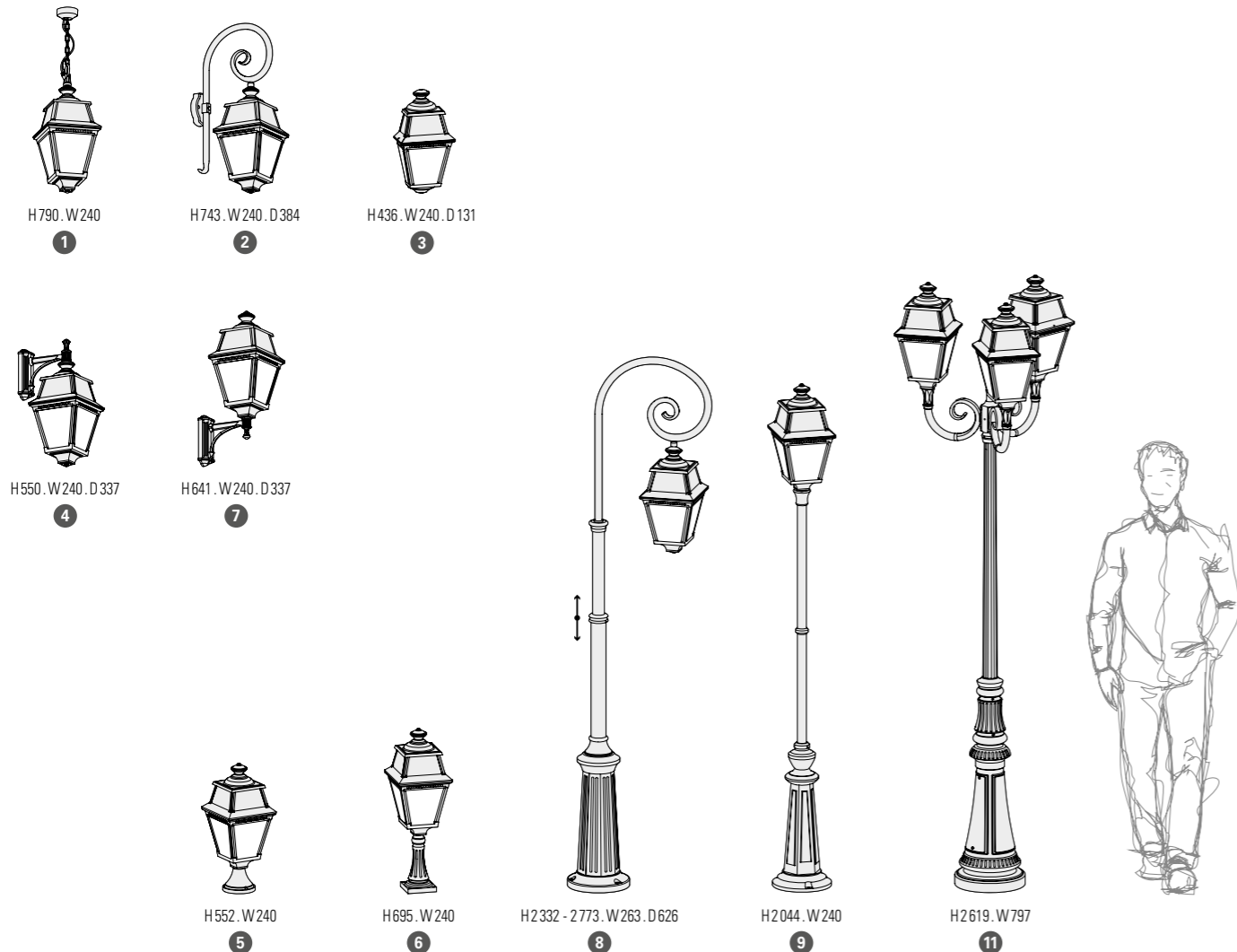

# Avenue 2

## REFERENCES

Replace ... with the colour code or the material code

MODELS	DIFFUSERS	E27	LED 10W 2700K warm white	LED 13W 2700K warm white	CORNER PLATES
1	CLEAR GLASS	102 001 ...		102 102 ...	
	OPAL PMMA			102 103 ...	
2	CLEAR GLASS	102 004 ...		102 105 ...	147 001 ...
	OPAL PMMA			102 106 ...	
3	CLEAR GLASS	102 007 ...	102 108 ...		
4	CLEAR GLASS	102 010 ...		102 111 ...	147 004 ...
	OPAL PMMA			102 112 ...	
5	CLEAR GLASS	102 013 ...		102 114 ...	
	OPAL PMMA			102 115 ...	
6	CLEAR GLASS	102 016 ...		102 117 ...	
	OPAL PMMA			102 118 ...	
7	CLEAR GLASS	102 019 ...		102 120 ...	147 004 ...
	OPAL PMMA			102 121 ...	
8	CLEAR GLASS	102 022 ...		102 123 ...	
	OPAL PMMA			102 124 ...	
9	CLEAR GLASS	102 025 ...		102 126 ...	
	OPAL PMMA			102 127 ...	
11	CLEAR GLASS	102 028 ...		102 129 ...	
	OPAL PMMA			102 130 ...	
SPARE DIFFUSERS					
	CLEAR GLASS		165 003 609		
	CLEAR GLASS		165 002 609 (model 3)		
	OPAL PMMA		165 003 606 (except model 3)		

## COLOUR CODES

Replace ... with the colour code

	RAL 9005 JET BLACK	000
	RAL 6009 BRITISH GREEN	019
	RAL 6009 FIR GREEN	067
	GREEN PATINA	008
	GOLD PATINA	009

Other colours on request

## MATERIAL CODES

Replace ... with the material code

	TINTED LACQUERED BRASS	070
	RAW BRASS	072

With Aluminium base Jet black 000 (RAL 9005) See pages 12-13

## MOUNTING

Wiring entry points in grey  
Fixing kit included (except model 11)  
Anchor bolts on request (model 11) p.302

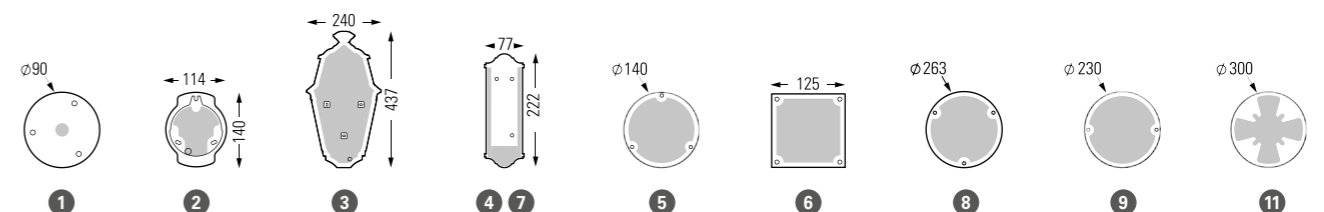



## Avenue 3

---

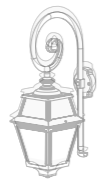

Avenue 2

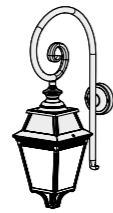

Avenue 3

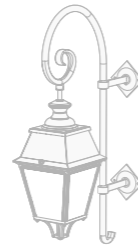

Avenue 4









# Avenue 3

Aluminium  
Clear glass or Opal PMMA diffuser  
IP44 / Class 1

## SOURCES

LED 18W - 2700K warm white (model 2)  
LED 18W - 3000K warm white (model 2)  
LED 35W - 2700K warm white (except model 2)  
LED 35W - 3000K warm white (except model 2)  
LED 26W or 35W - 4000K on request  
E27 - 105W max H 220 mm max (except model 2)  
Ø 66 mm - H 200 mm max (model 2)

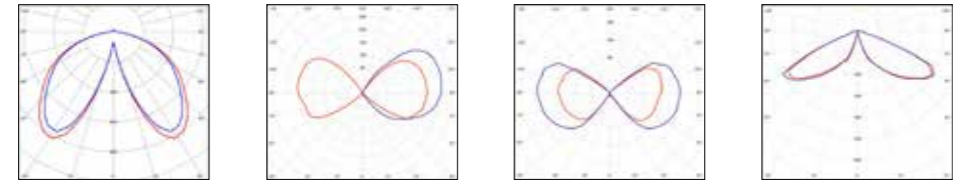

Models 1 to 12 except 2  
LED 35W  
Real light output/opal - 3681 lm  
Real light output/clear - 3078 lm  
CRI > 80

Model 2  
E27 (2450 lm)  
Real light output - 1304 lm

Models 4 to 8 and 11, 12  
E27 (2450 lm)  
Real light output - 1603 lm

Models 1, 3, 9  
E27 (2450 lm)  
Real light output - 506 lm

## MODELS

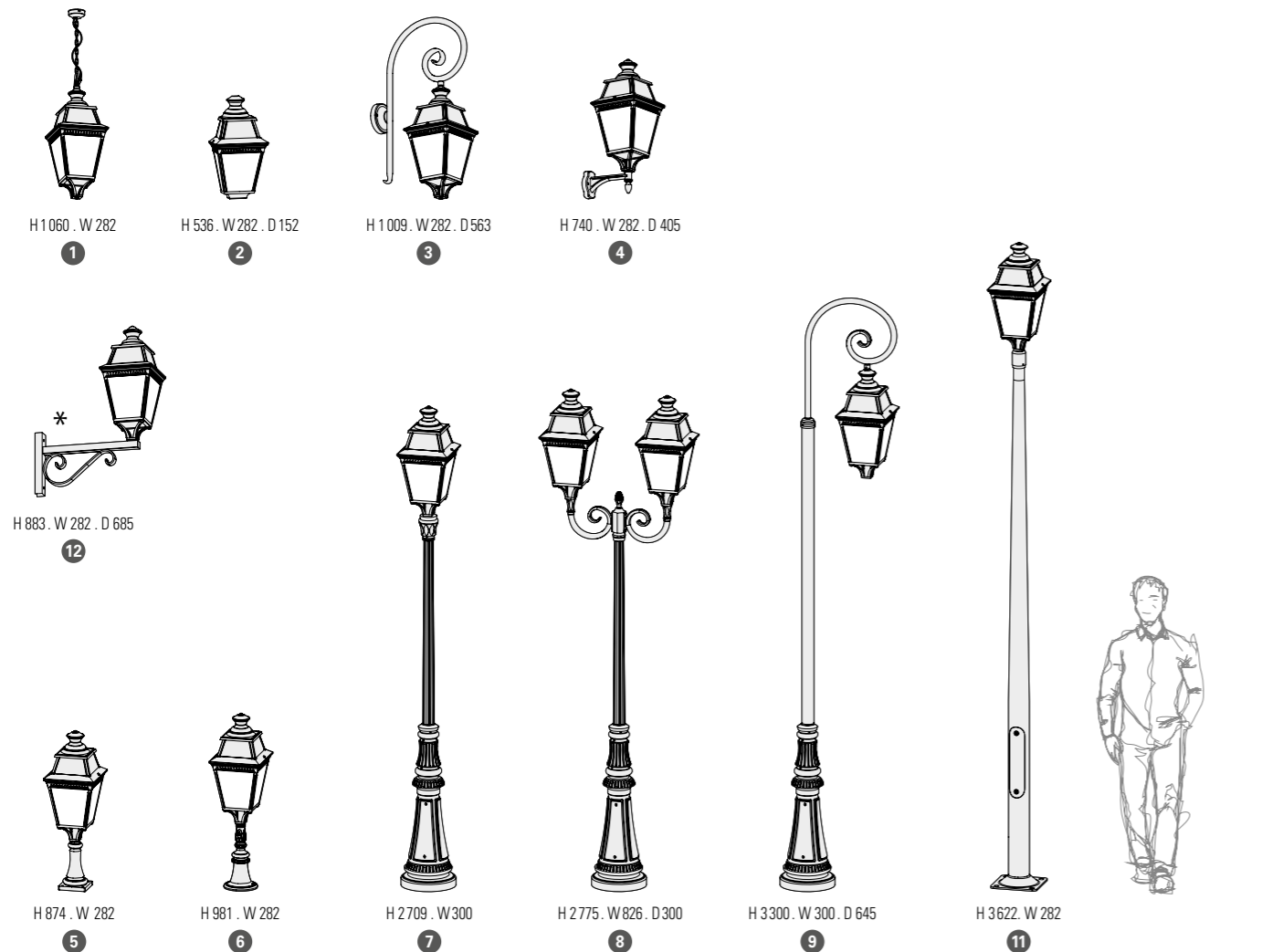

\* 12 : bichromated steel support

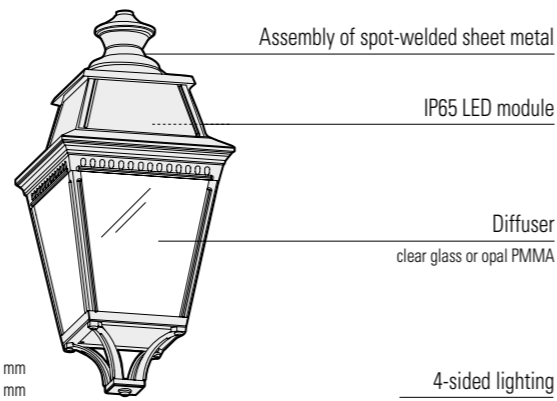

PRM Average Illuminance 20 lux p.300  
Model 3

LED 35W	Pathway	Spacing
H 2,50 m	2,50 m	20,00 m

# Avenue 3

## REFERENCES

Replace ... with the colour code

MODELS	DIFFUSERS	E27	LED 18W 2700K warm white	LED 18W 3000K warm white	LED 35W 2700K warm white	LED 35W 3000K warm white	CORNER PLATES
1	CLEAR GLASS	103 001 ...			103 202 ...	103 102 ...	
	OPAL PMMA				103 204 ...	103 104 ...	
2	CLEAR GLASS	103 006 ...	103 261 ...	103 161 ...			
	OPAL PMMA		103 262 ...	103 162 ...			
3	CLEAR GLASS	103 007 ...			103 208 ...	103 108 ...	147 003 ...
	OPAL PMMA				103 210 ...	103 110 ...	
4	CLEAR GLASS	103 012 ...			103 213 ...	103 113 ...	147 001 ...
	OPAL PMMA				103 215 ...	103 115 ...	
5	CLEAR GLASS	103 017 ...			103 218 ...	103 118 ...	
	OPAL PMMA				103 220 ...	103 120 ...	
6	CLEAR GLASS	103 022 ...			103 223 ...	103 123 ...	
	OPAL PMMA				103 225 ...	103 125 ...	
7	CLEAR GLASS	103 027 ...			103 228 ...	103 128 ...	
	OPAL PMMA				103 230 ...	103 130 ...	
8	CLEAR GLASS	103 032 ...			103 233 ...	103 133 ...	
	OPAL PMMA				103 235 ...	103 135 ...	
9	CLEAR GLASS	103 037 ...			103 238 ...	103 138 ...	
	OPAL PMMA				103 240 ...	103 140 ...	
11	CLEAR GLASS	103 057 ...			103 258 ...	103 158 ...	
	OPAL PMMA				103 260 ...	103 160 ...	
12	CLEAR GLASS	103 052 ...			103 253 ...	103 153 ...	
	OPAL PMMA				103 255 ...	103 155 ...	

SPARE DIFFUSERS

CLEAR GLASS	165 005 609
CLEAR GLASS (model 2)	165 004 609
OPAL PMMA (except model 2)	165 005 606

## COLOUR CODES

Replace ... with the colour code

Models 1 to 9 and model 12	RAL 9005 JET BLACK	000
	RAL 6009 FIR GREEN	067
	GREEN PATINA	008
	GOLD PATINA	009
Model 11	RAL 9005 JET BLACK	000
	RAL 6009 BRITISH GREEN	019
	RAL 6009 FIR GREEN	067

Other colours on request

## MOUNTING

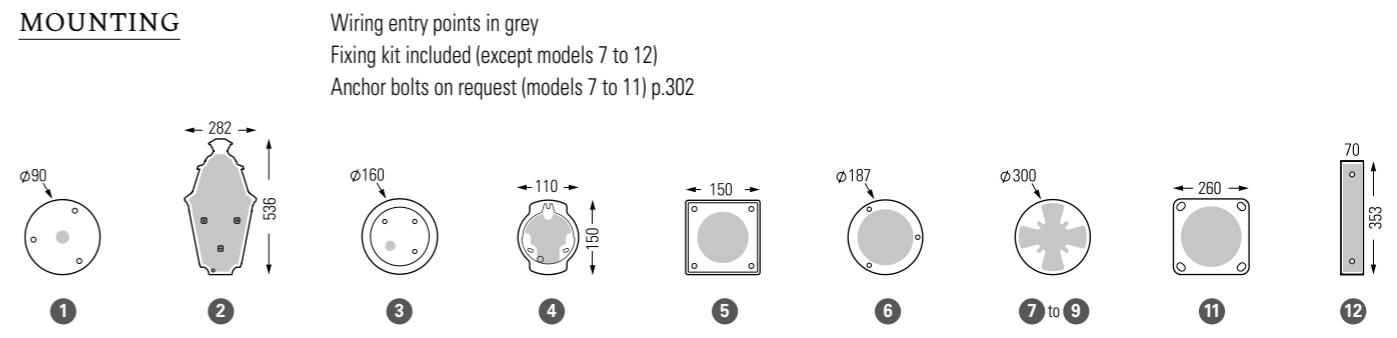

Wiring entry points in grey  
Fixing kit included (except models 7 to 12)  
Anchor bolts on request (models 7 to 11) p.302



## Avenue 4

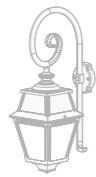

Avenue 2

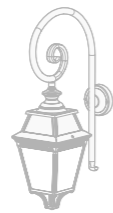

Avenue 3

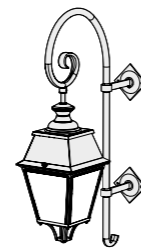

Avenue 4





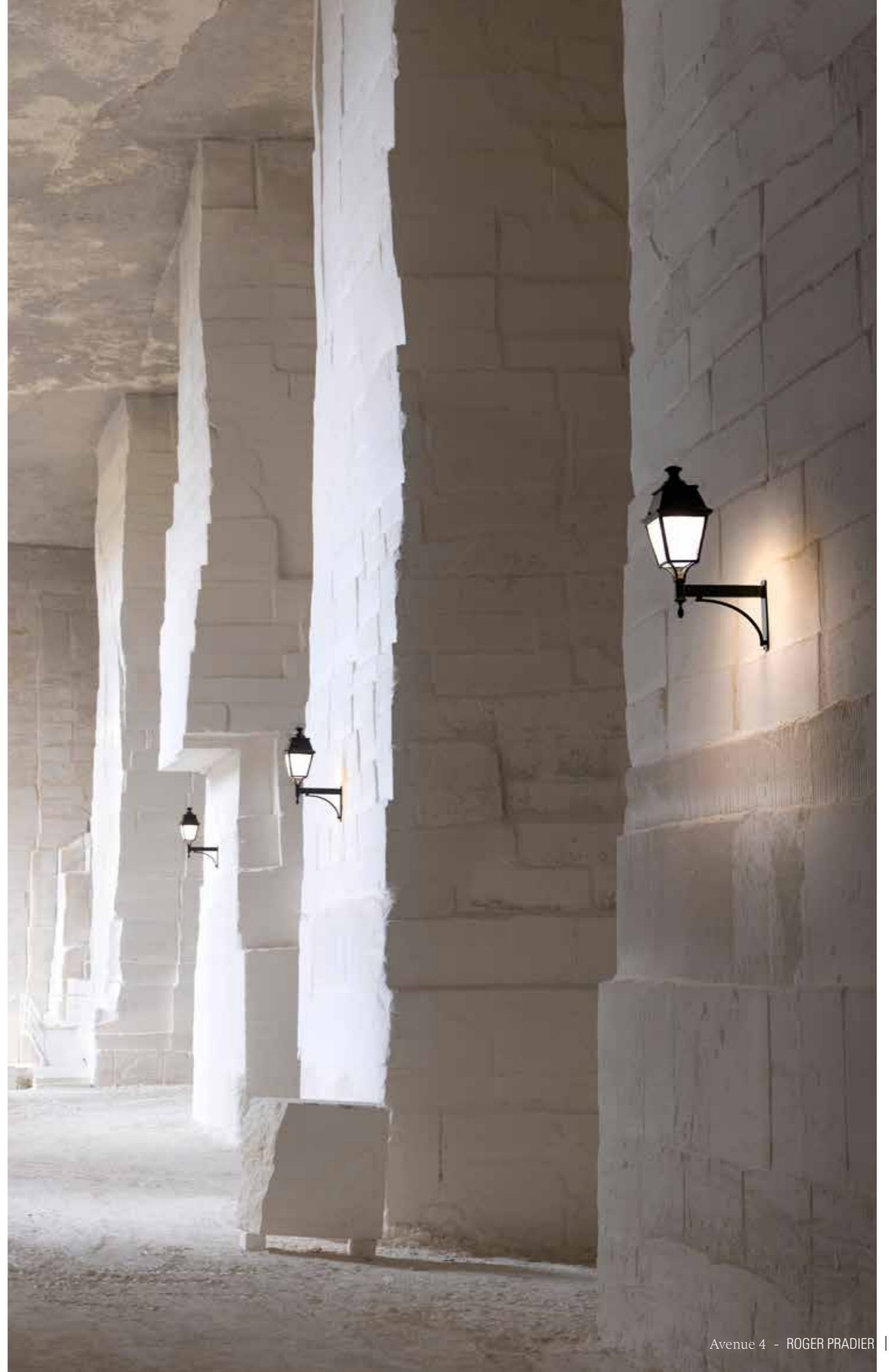



# Avenue 4

Aluminium  
 Opal or clear structured PMMA diffuser for IP65  
 Opal or clear PMMA diffuser for IP44  
 IP65 - LED (lantern except model 2 IP44) / IP44 - E27 (IP65 version on request except model 2)  
 Class 1

## SOURCES

LED 35W - 2700K warm white  
 LED 35W - 3000K warm white  
 LED 26W or 35W - 4000K on request  
 Asymmetric and dimmable LED module on request  
 E27 - 105W max H280 mm max (except model 2)  
 Ø80 mm - H160 mm max (model 2)

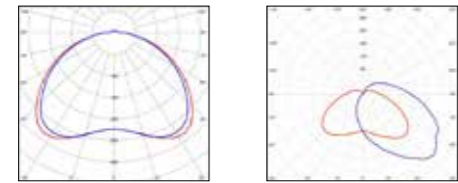
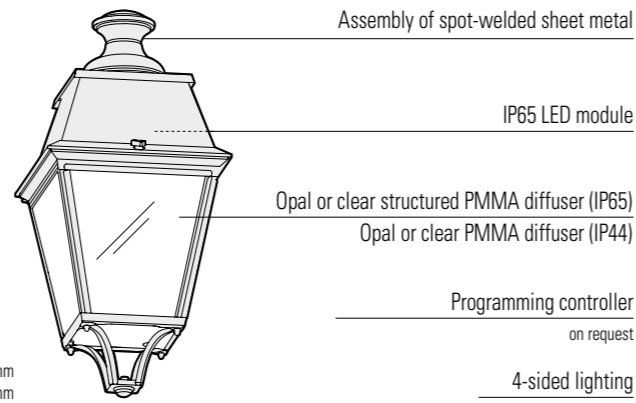

Models 1 to 9 except 2  
 LED 35W  
 Real light output/opal - 4665 lm  
 Real light output/clear - 4345 lm  
 CRI > 80

Model 2  
 LED 35W  
 Real light output/opal - 2596 lm  
 Real light output/clear - 2229 lm  
 CRI > 80

PRM Average Illuminance 20 lux p.300  
 Model 5

LED 35W	Pathway	Spacing
H 4,50 m	4,50 m	15,00 m

## MODELS

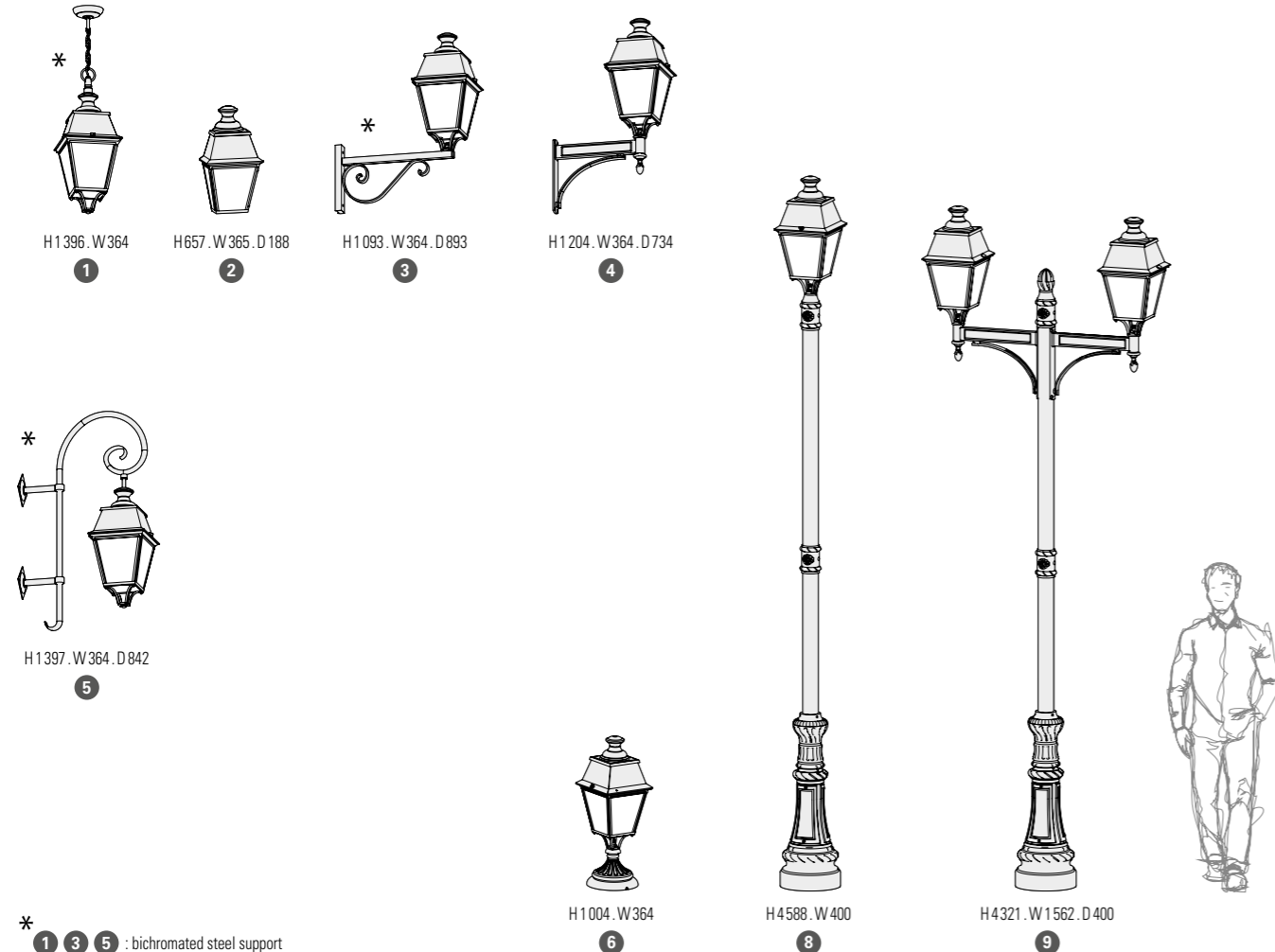

\* 1 3 5 : bichromated steel support

# Avenue 4

## REFERENCES

Replace ●●● with the colour code

MODELS	DIFFUSERS	E27	LED 35W 2700K warm white	LED 35W 3000K warm white	SPARE DIFFUSERS
1	CLEAR PMMA	104 001 ●●●			165 007 605
	OPAL PMMA	104 018 ●●●			165 007 606
2	CLEAR PMMA	104 035 ●●●	104 349 ●●●	104 249 ●●●	165 006 605
	OPAL PMMA	104 040 ●●●	104 351 ●●●	104 251 ●●●	165 006 606
3	CLEAR PMMA	104 045 ●●●			165 008 605
	OPAL PMMA	104 062 ●●●			165 008 606
4	CLEAR PMMA	104 079 ●●●			165 008 605
	OPAL PMMA	104 096 ●●●			165 008 606
5	CLEAR PMMA	104 113 ●●●			165 007 605
	OPAL PMMA	104 130 ●●●			165 007 606
6	CLEAR PMMA	104 215 ●●●			165 008 605
	OPAL PMMA	104 232 ●●●			165 008 606
8	CLEAR PMMA	104 147 ●●●			165 008 605
	OPAL PMMA	104 164 ●●●			165 008 606
9	CLEAR PMMA	104 181 ●●●			165 008 605
	OPAL PMMA	104 198 ●●●			165 008 606

MODELS	DIFFUSERS	LED 35W 2700K warm white	LED 35W 3000K warm white	SPARE DIFFUSERS
1	CLEAR STRUCTURED PMMA	104 353 ●●●	104 253 ●●●	165 009 608
	OPAL PMMA	104 354 ●●●	104 254 ●●●	165 009 606
3	CLEAR STRUCTURED PMMA	104 355 ●●●	104 255 ●●●	165 010 608
	OPAL PMMA	104 356 ●●●	104 256 ●●●	165 010 606
4	CLEAR STRUCTURED PMMA	104 357 ●●●	104 257 ●●●	165 010 608
	OPAL PMMA	104 358 ●●●	104 258 ●●●	165 010 606
5	CLEAR STRUCTURED PMMA	104 359 ●●●	104 259 ●●●	165 009 608
	OPAL PMMA	104 360 ●●●	104 260 ●●●	165 009 606
6	CLEAR STRUCTURED PMMA	104 361 ●●●	104 261 ●●●	165 010 608
	OPAL PMMA	104 362 ●●●	104 262 ●●●	165 010 606
8	CLEAR STRUCTURED PMMA	104 363 ●●●	104 263 ●●●	165 010 608
	OPAL PMMA	104 364 ●●●	104 264 ●●●	165 010 606
9	CLEAR STRUCTURED PMMA	104 365 ●●●	104 265 ●●●	165 010 608
	OPAL PMMA	104 366 ●●●	104 266 ●●●	165 010 606

## COLOUR CODES

Replace ●●● with the colour code

	RAL 9005 JET BLACK	000
	GREEN PATINA	008
	GOLD PATINA	009

Other colours on request

## MOUNTING

Wiring entry points in grey - Fixing kit included (only model 2)

Anchor bolts on request (models 6, 8, 9) p.302

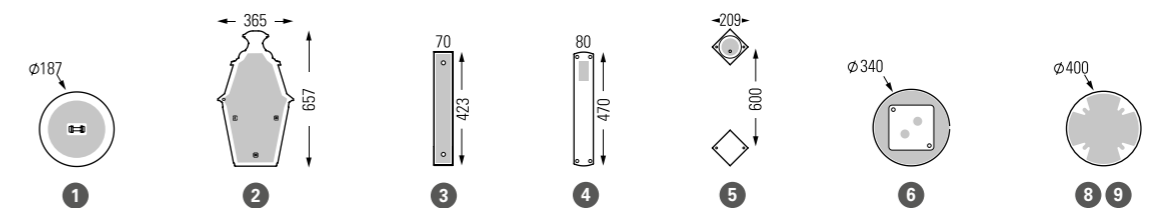



# Victoria

---





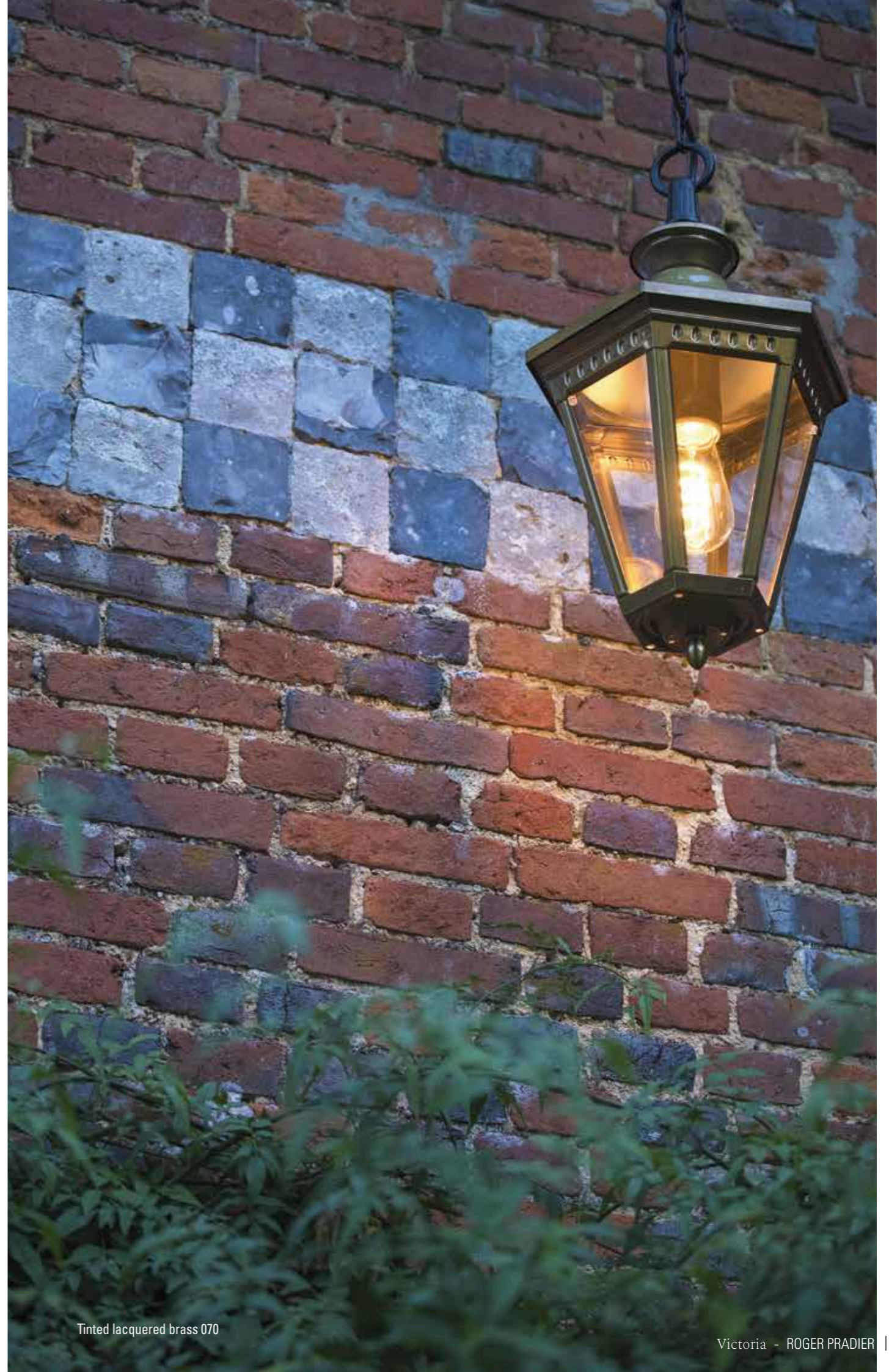



# Victoria

Aluminium - Tinted Lacquered brass - Raw brass  
 Clear polycarbonate diffuser / Opal polycarbonate diffuser on request  
 IP44 / Class 1

## SOURCES

E27 - 105W max (except model 1) H 200 mm max  
 E27 - 75W max (model 1) Ø 63 mm - H 120 mm max

## MODELS

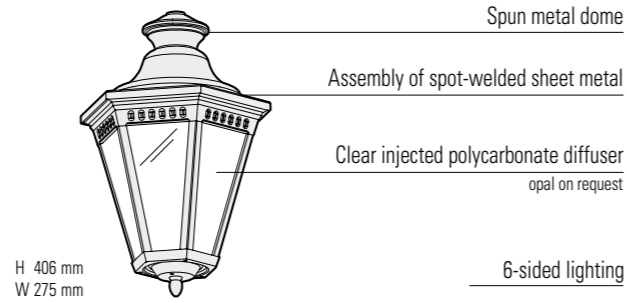
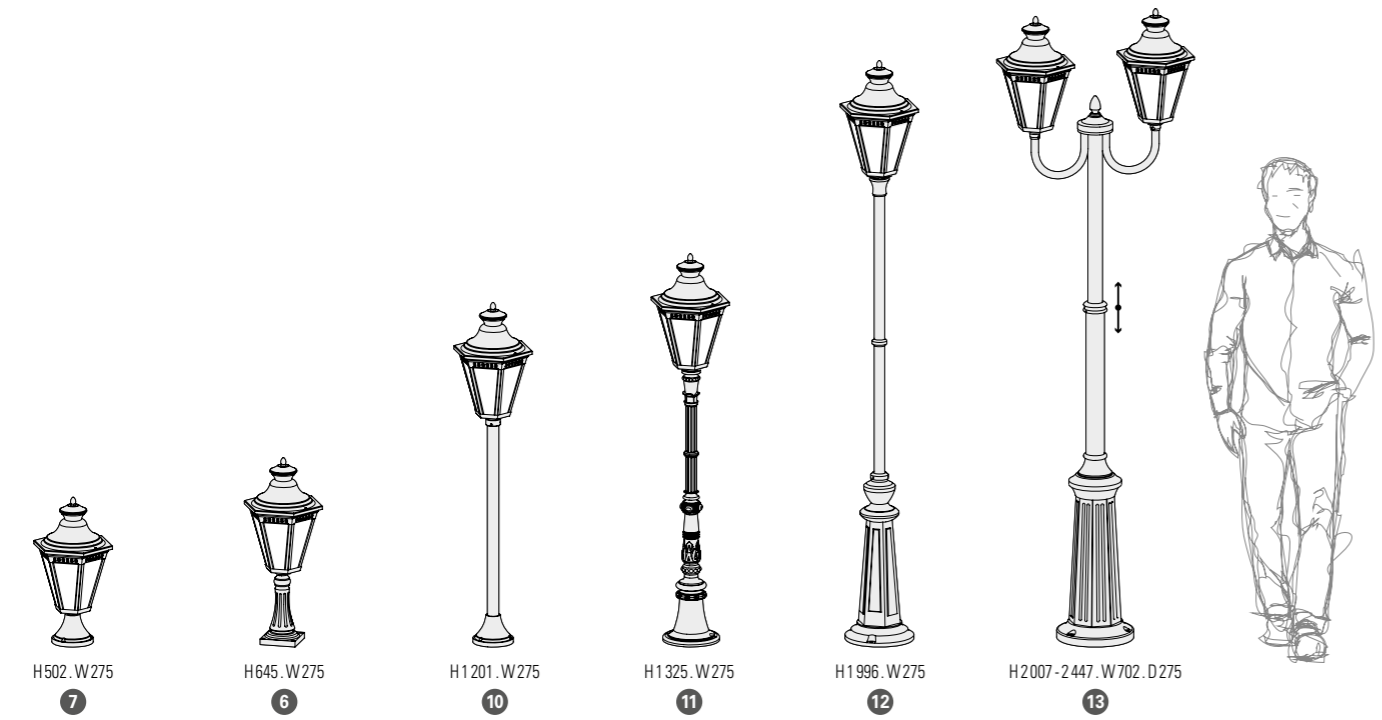
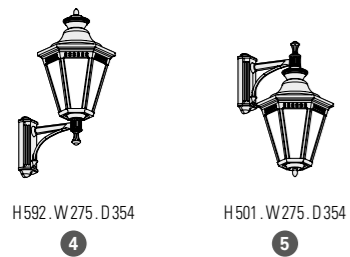

# Victoria

## REFERENCES

Replace ... with the colour code or the material code

MODELS	E27	CORNER PLATES
1	164 001 ...	
2	164 002 ...	
3	164 003 ...	147 001 ...
4	164 004 ...	147 004 ...
5	164 005 ...	147 004 ...
6	164 006 ...	
7	164 007 ...	
10	164 008 ...	
11	164 009 ...	
12	164 010 ...	
13	164 011 ...	
SPARE DIFFUSERS		
165 069 601 (model 1)		
165 070 601		

## COLOUR CODES

Replace ... with the colour code

	RAL 9005 JET BLACK	000
	SLATE GREY	059
	WHITE	001
	OLD RUSTIC	046
	GREEN PATINA	008
	GOLD PATINA	009

Other colours on request

## MATERIAL CODES

Replace ... with the material code

	TINTED LACQUERED BRASS	070
	RAW BRASS	072

See pages 12-13

With Aluminium base Jet black colour 000 (RAL 9005)

## MOUNTING

Wiring entry points in grey

Fixing kit included

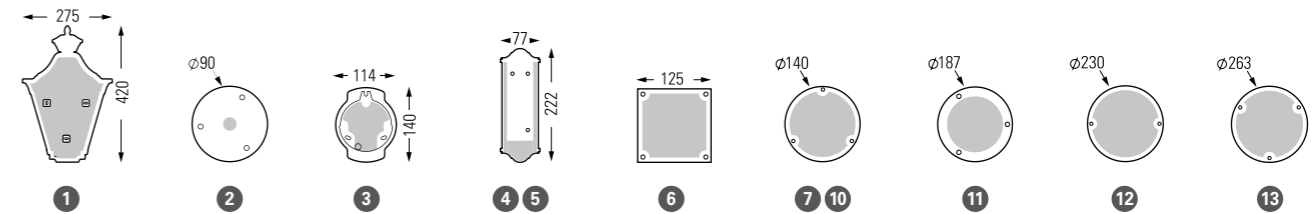



# Louis XIII

---







Tinted lacquered brass 070



Tinted lacquered brass 070



Tinted lacquered brass 070



# Louis XIII

Aluminium - Tinted Lacquered brass - Raw brass  
Clear glass or opal PMMA diffuser on request  
IP44 / Class 1

## SOURCES

LED 10W - 2700K warm white  
LED 13W - 2700K warm white  
E27 - 105W max H 220 mm max (except model 2)  
Ø66 mm - H 200 mm max (model 2)

PRM Average Illuminance 20 lux p.300  
Model 3

LED 13W	Pathway	Spacing
H 2,00m	2,00m	5,50m

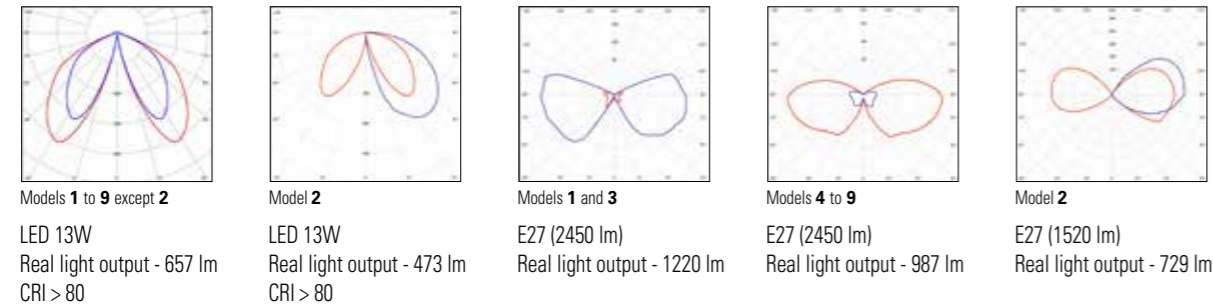
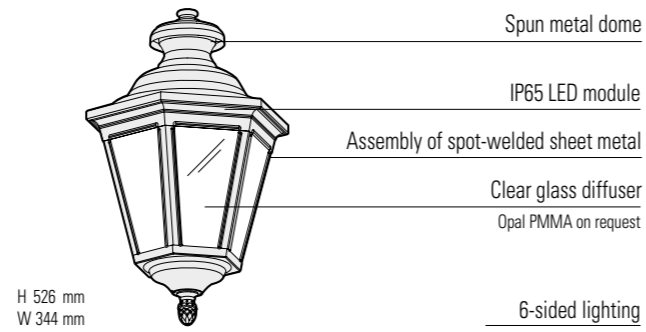

## MODELS

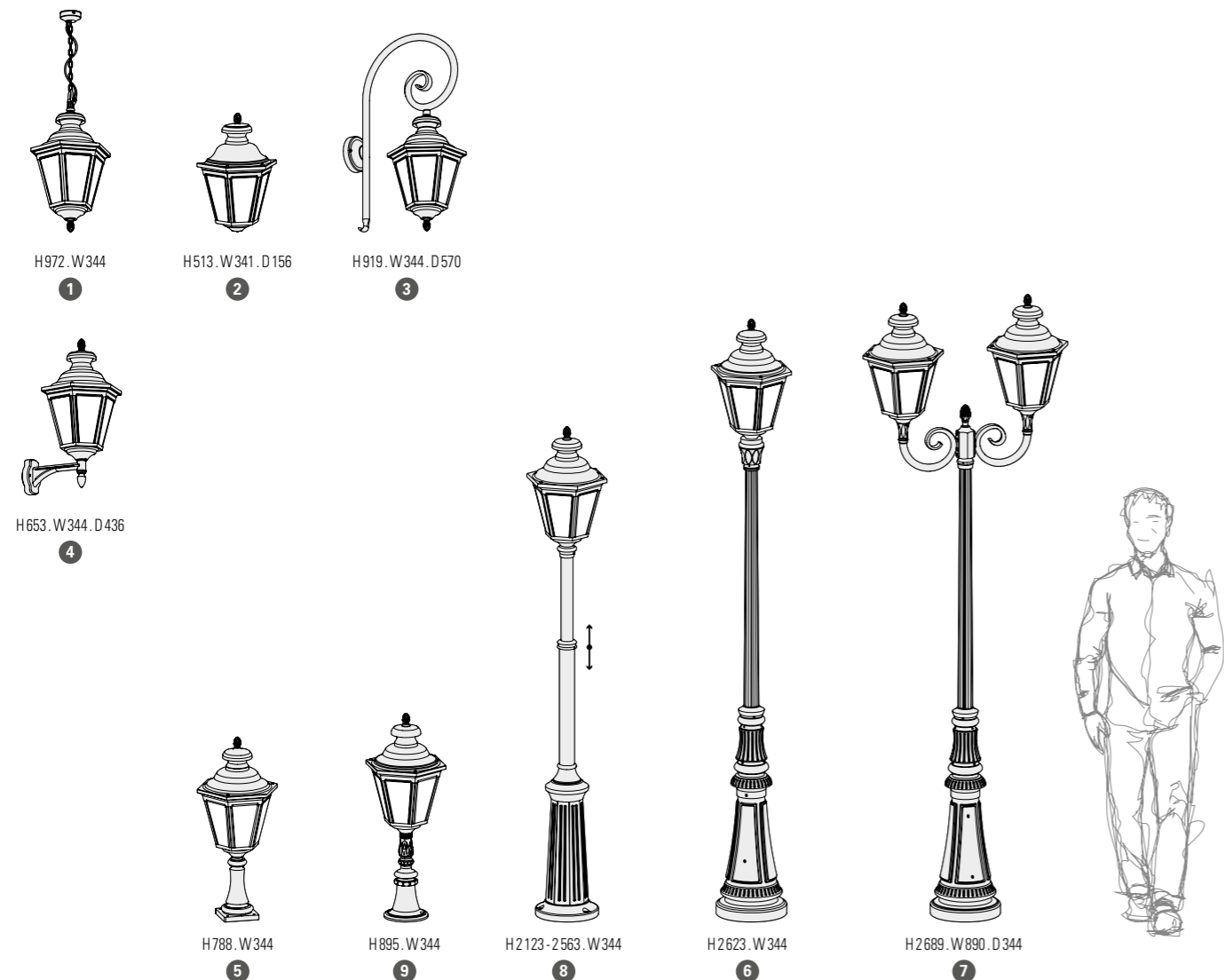

# Louis XIII

## REFERENCES

Replace ... with the colour code or the material code

MODELS	E27	LED 10W 2700K warm white	LED 13W 2700K warm white	CORNER PLATES
1	130 001 ...		130 102 ...	
2	130 003 ...	130 104 ...		
3	130 005 ...		130 106 ...	147 003 ...
4	130 007 ...		130 108 ...	147 001 ...
5	130 009 ...		130 110 ...	
6	130 011 ...		130 112 ...	
7	130 013 ...		130 114 ...	
8	130 015 ...		130 116 ...	
9	130 017 ...		130 118 ...	
SPARE DIFFUSERS				
165 034 609				
165 033 609 (model 2)				

## COLOUR CODES

Replace ... with the colour code

	RAL 9005 JET BLACK	000
	OLD RUSTIC	046
	GREEN PATINA	008
	GOLD PATINA	009

Other colours on request

## MATERIAL CODES

Replace ... with the material code

	TINTED LACQUERED BRASS	070
	RAW BRASS	072 See pages 12-13

With Aluminium base Jet black colour 000 (RAL 9005)

## MOUNTING

Wiring entry points in grey  
Fixing kit included (except models 6, 7)  
Anchor bolts on request (models 6, 7) p.302

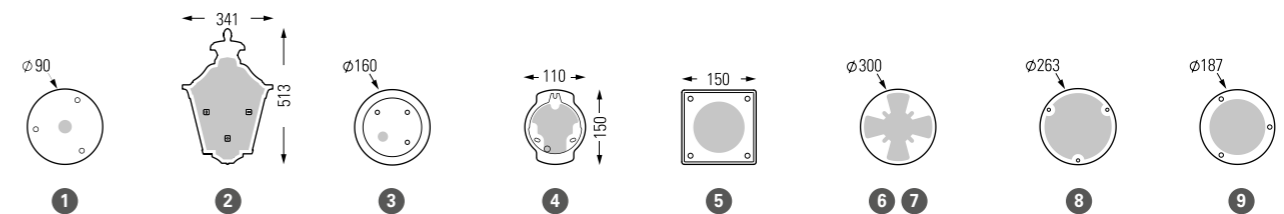



# Citadelle

---







Patinated copper (unvarnished) 083

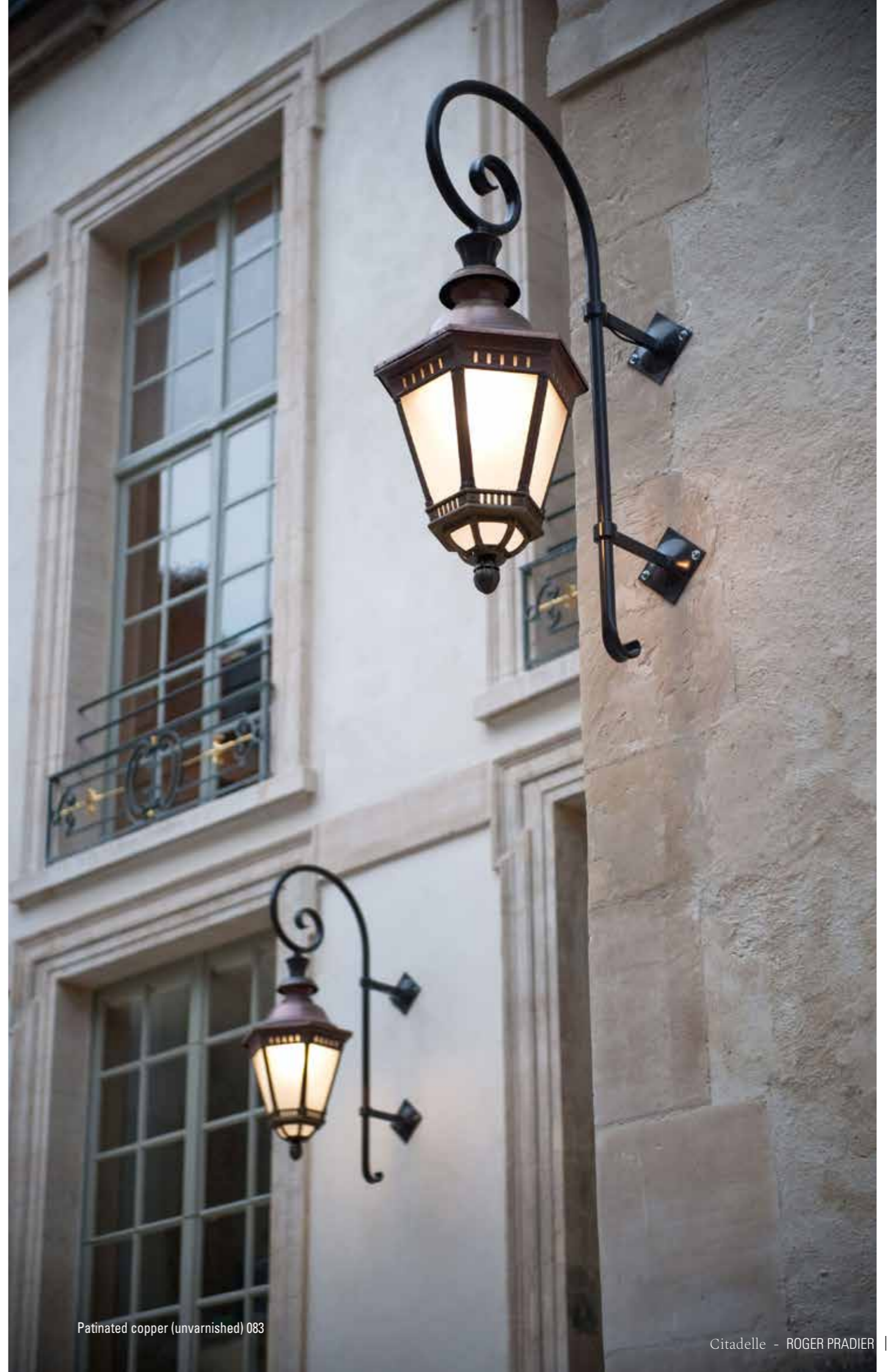

Patinated copper (unvarnished) 083



# Citadelle

Aluminium - Patinated copper (unvarnished)  
Opal PMMA diffuser  
IP66 (lantern) / Class 1

## SOURCES

LED 35W - 2700K warm white  
LED 35W - 3000K warm white  
LED 35W - 4000K on request  
E27 - 105W max H280 mm max

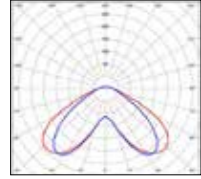

PRM Average Illuminance 20 lux p.300  
Model 5

LED 35W	Pathway	Spacing
H 4,00 m	4,00 m	16,00 m

LED 35W  
Real light output - 4227 lm  
CRI > 80

## MODELS



H1468 . W509  
1



H1294 . W509 . D805  
2

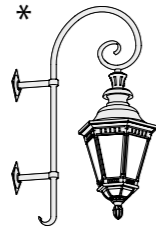

H1397 . W509 . D914  
3



H1083 . W509  
4

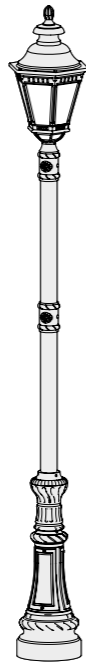

H4178 . W509  
5

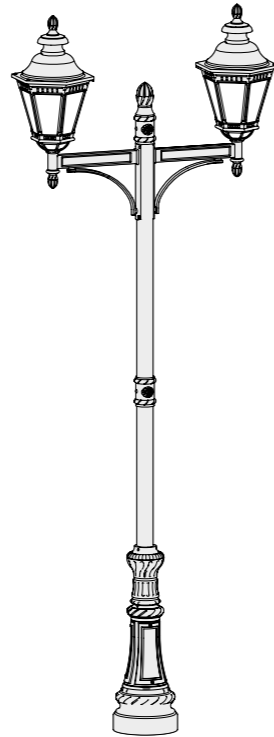

H4411 . W1703 . D509  
7

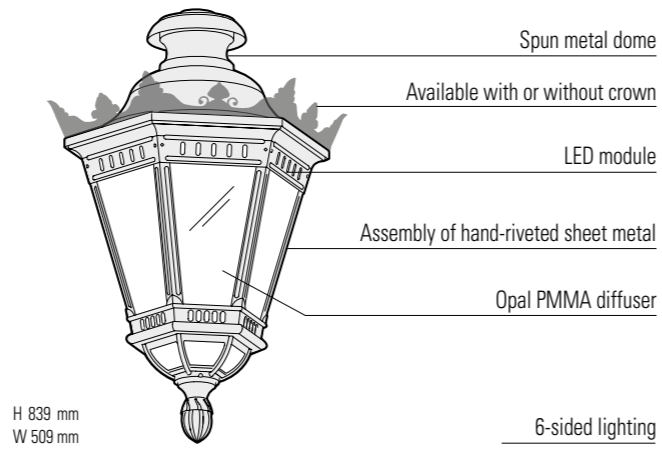

# Citadelle

## REFERENCES

Replace ... with the colour code or the material code

Without crown

MODELS	E27	LED 35W 2700K warm white	LED 35W 3000K warm white
1	116 001 ...	116 203 ...	116 103 ...
2	116 011 ...	116 213 ...	116 113 ...
3	116 021 ...	116 223 ...	116 123 ...
4	116 051 ...	116 253 ...	116 153 ...
5	116 031 ...	116 233 ...	116 133 ...
7	116 041 ...	116 243 ...	116 143 ...

With crown

MODELS	E27	LED 35W 2700K warm white	LED 35W 3000K warm white
1	116 002 ...	116 204 ...	116 104 ...
2	116 012 ...	116 214 ...	116 114 ...
3	116 022 ...	116 224 ...	116 124 ...
4	116 052 ...	116 254 ...	116 154 ...
5	116 032 ...	116 234 ...	116 134 ...
7	116 042 ...	116 244 ...	116 144 ...

### SPARE DIFFUSERS

165 020 606 (models 1 and 3)

165 021 606

## COLOUR CODES

Replace ... with the colour code

	RAL 9005 JET BLACK	000
	GREEN PATINA	008
	GOLD PATINA	009

Other colours on request

## MATERIAL CODE

Replace ... with the material code

	PATINATED COPPER (UNVARNISHED)	083
--	--------------------------------	-----

With Aluminium base Jet black colour 000 (RAL 9005)

## MOUNTING

Wiring entry points in grey

Fixing kit not included

Anchor bolts on request (models 4, 5, 7) p.302

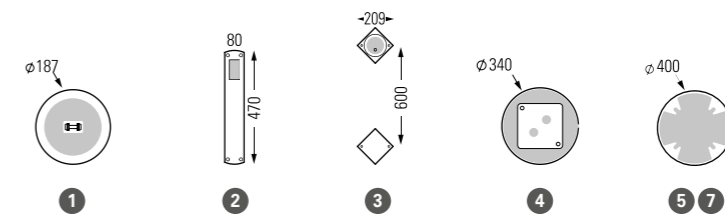

\* 1 3 : bichromated steel support



# Technical Specifications

---

## Lanterns sizes

4 sided p.290  
6 sided p.292

---

## Wall lights with motion sensor

p.294

---

## Bollards with motion sensor

p.295

---

## Bollards with Green'Up socket

### Bollards with IP55 sockets

p.296

---

## Bornéo: electrical sockets / motion sensor

p.298

---

## Commitment against light pollution

### Compliance with PRM standards

p.300

---

## Accessories

p.302

---

## Ingress Protection (IP) ratings

p.304

---

## Glossary

p.305

---

## Information

p.305

---

## Colour chart

p.308



# Lanterns sizes

## 4 sided lanterns

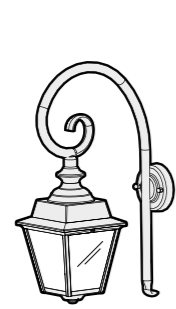

Chenonceau  
p.224

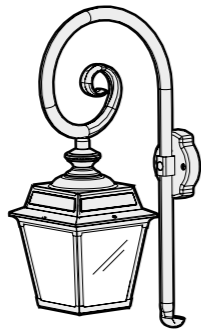

Place des Vosges 1  
Tradition  
p.228

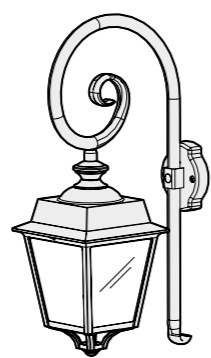

Place des Vosges 1  
Évolution  
p.234

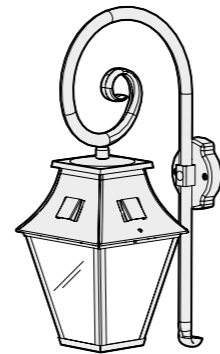

Vieille France  
p.214

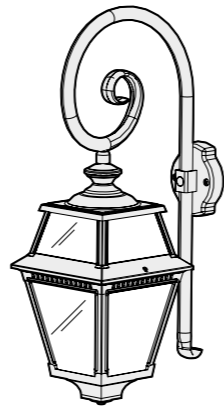

Place des Vosges 2  
p.240

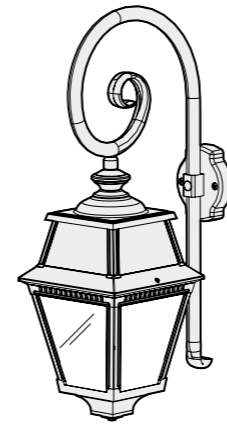

Avenue 2  
p.252

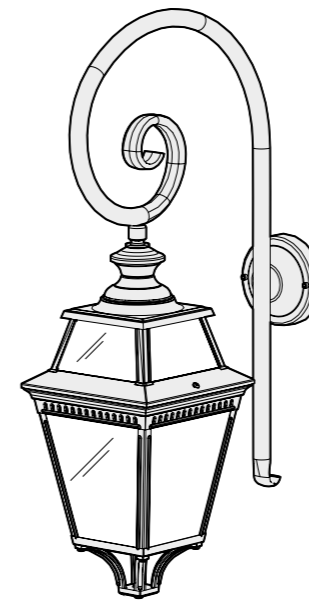

Place des Vosges 3  
p.246

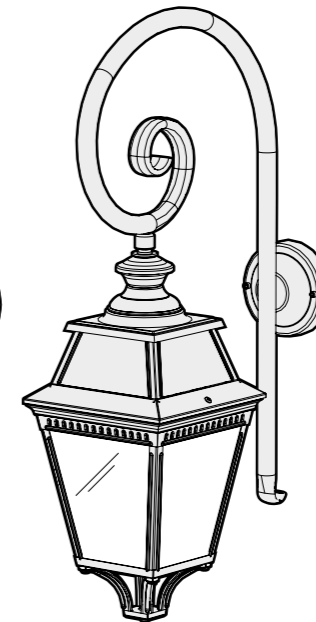

Avenue 3  
p.258

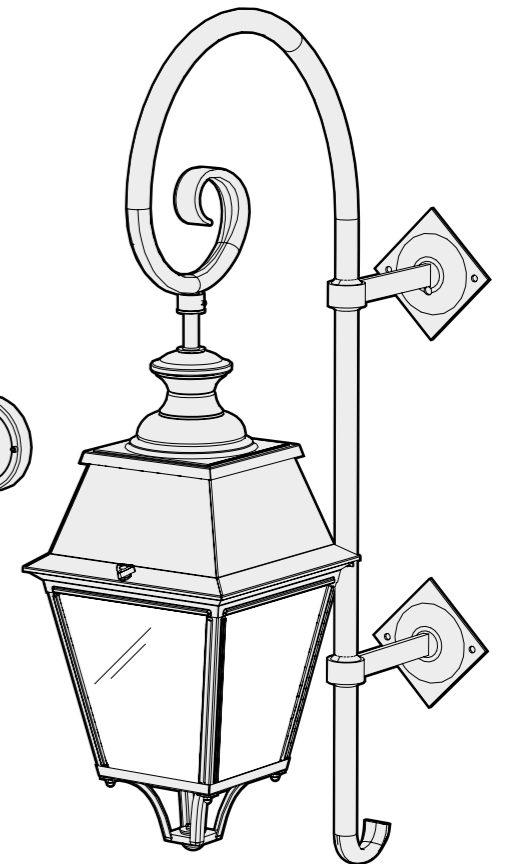

Avenue 4  
p.264



# Lanterns sizes

6 sided lanterns

---

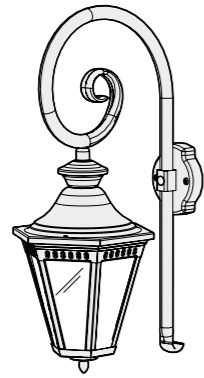

Victoria  
p.270

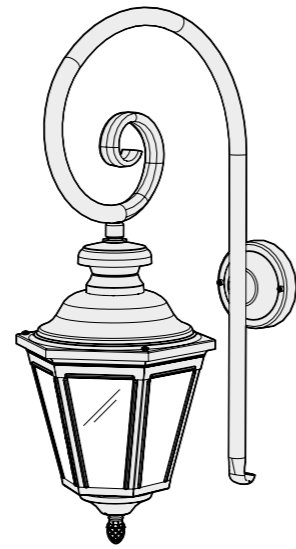

Louis XIII  
p.276

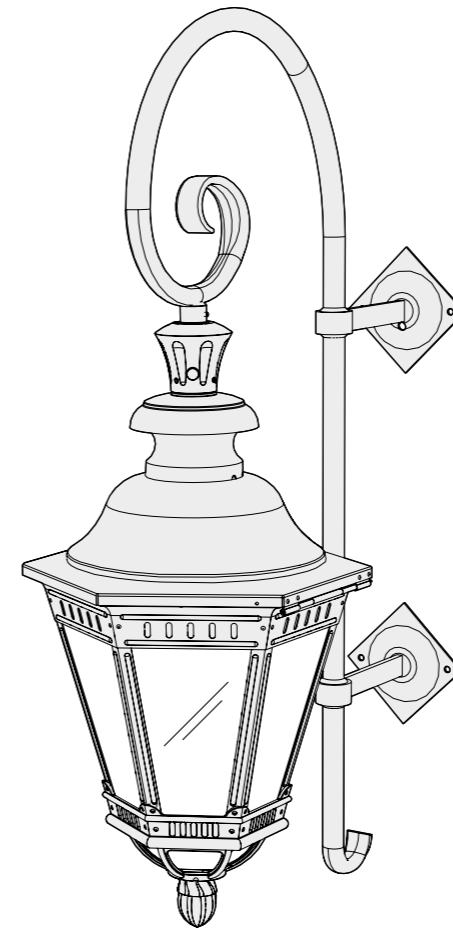

Citadelle  
p.282

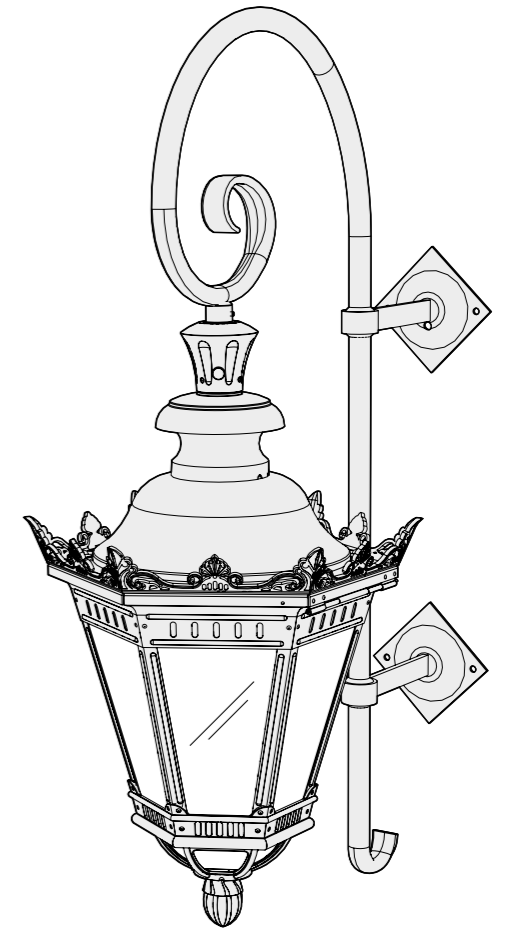

Citadelle  
p.282



## Wall lights with motion sensor

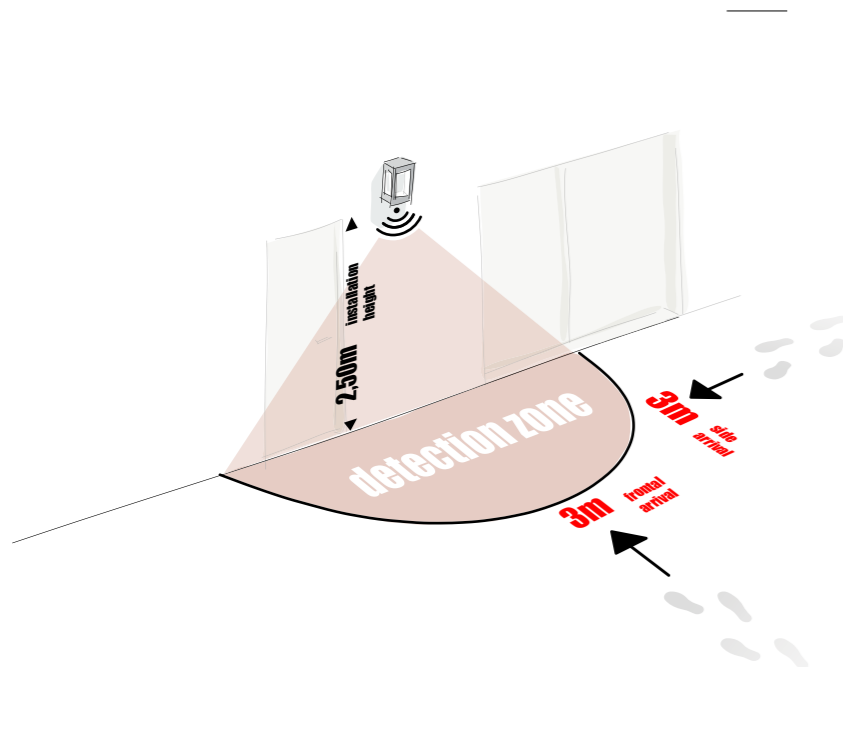

Recommended mounting height 2,50 m  
installed at a height of 2 m,  
the motion detector range is 2,50 m

Available settings via remote control:

- Switch on time: from 15s to 30min
- Trigger threshold: 20 lux to 1000 lux
- Sensivity
- Forced operation



Supplied remote control

Exclusively on these models

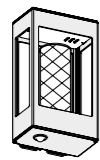

Tetra  
p.48

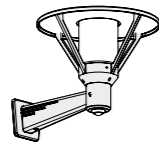

Bermude  
p.148

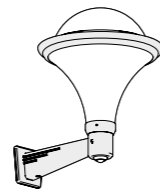

Dallas  
p.182

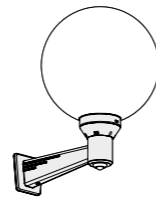

Moon  
p.188

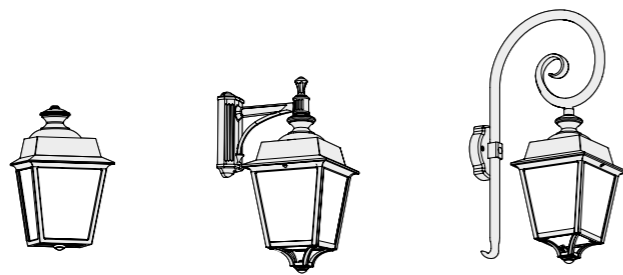

Place des Vosges 1 Evolution  
p.234

## Bollards with motion sensor

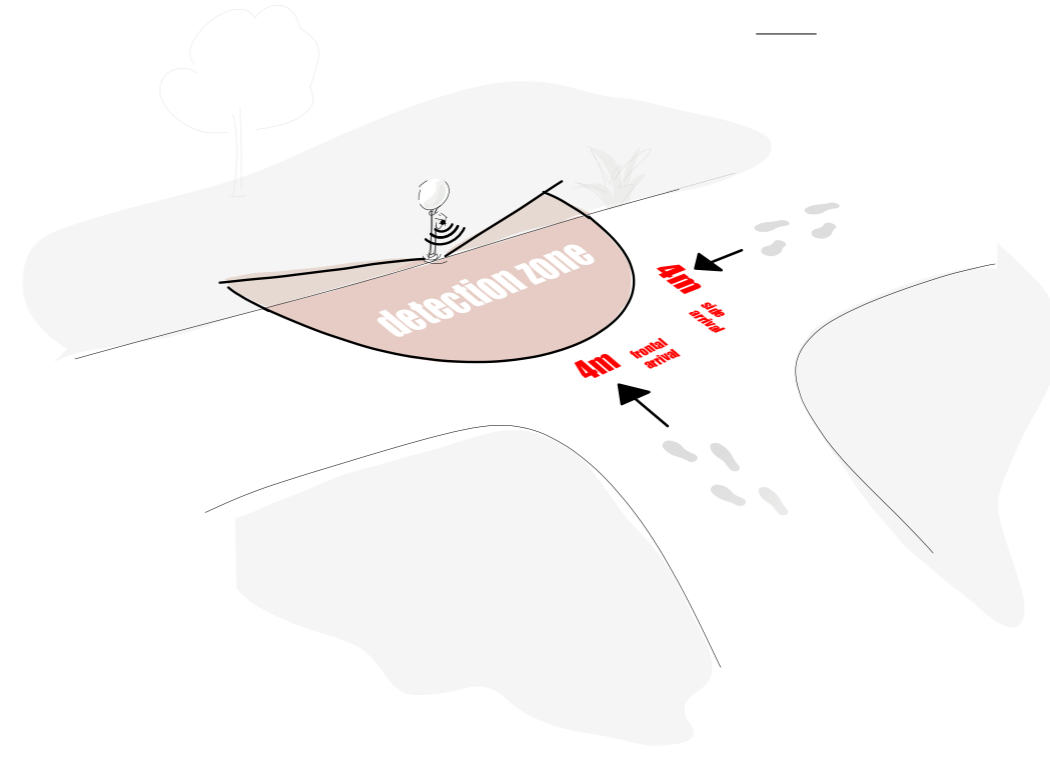

Manual settings

Switch on time:  
1 s to 20 min

Trigger threshold:  
5 lux to 1000 lux

Adjustable sensitivity

Maximum power per detector  
for several fixtures:  
- up to 100W LED

White detection block for white products  
Black detection block for other colors

Removable  
motion sensor 

Exclusively on these models

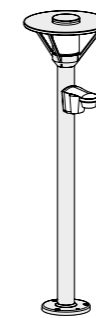

Bermude  
p.148

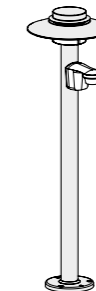

Kerlouan  
p.156

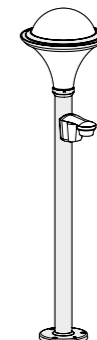

Dallas  
p.182

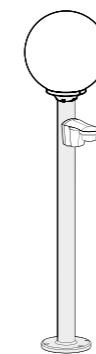

Moon  
p.188

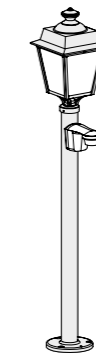

Place des Vosges 1  
Evolution  
p.234

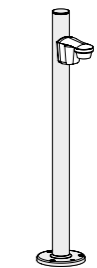

Bornéo  
p.298



## Bollards with Green'Up socket

Green'Up socket for electric and hybrid vehicles

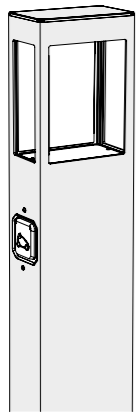

The EV socket is reinforced to safely support an intensity of up to 16 Amps, which reduces the charging time of your vehicle by almost half, particularly if it is equipped with a Green'Up cable.

Type E socket - Other types on request.



Exclusively on  
Tetra Model 4  
p.48

## Bollards with IP55 sockets

Country-specific sockets  
Separate power supply: socket/light

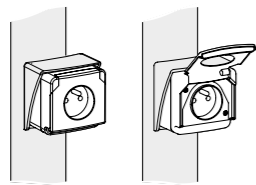
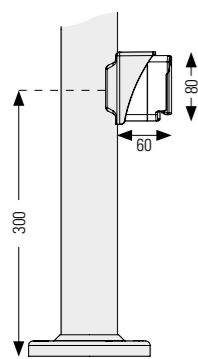

Nota bene : The standard sockets integrated into Roger Pradier® bollards can withstand a maximum intensity of 8 Amps and are therefore not suitable for charging an electric vehicle.



Tetra  
p.48



Brick<sup>2</sup>  
p.54

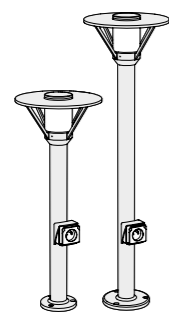

Bermude  
p.148

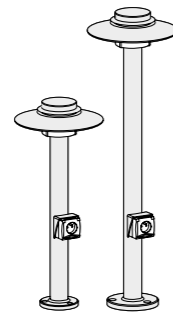

Kerlouan  
p.156

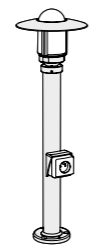

Newpark  
p.172

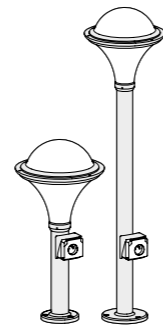

Dallas  
p.182

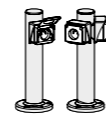

Bornéo  
p.298





# Bornéo

## Electrical sockets / motion sensor

Aluminium  
IP44 (models 1 to 3) - IP55 (model 4) / Class 1 - IP55 Sockets

### MODELS

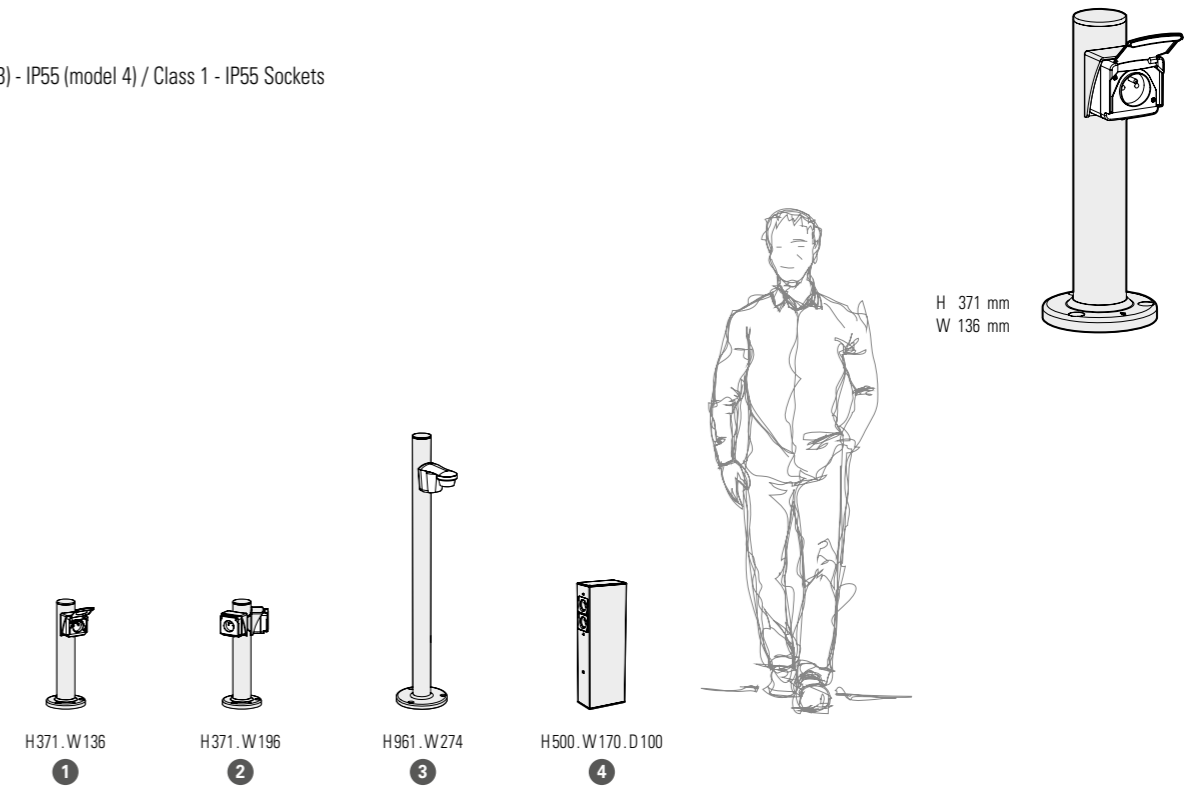

### REFERENCES

Replace **...** with the colour code

MODELS	FRENCH SOCKETS	SCHUKO SOCKETS Type F	SWISS SOCKETS Type J	SENSOR
1	107 001 ...	107 002 ...	107 004 ...	
2	107 006 ...	107 007 ...	107 009 ...	
3				107 011 ...
4	107 012 ...	107 013 ...	107 014 ...	

### COLOUR CODES

Replace **...** with the colour code

	DARK GREY 006		OLD RUSTIC 046
	SLATE GREY 059		SANDSTONE 054
	METAL GREY 023		RAL 6009 BRITISH GREEN 019
	WHITE 001		RAL 6009 FIR GREEN 067
Other colours on request			RAL 5011 STEEL BLUE 065

### MOUNTING

Wiring entry points in grey  
Fixing kit included

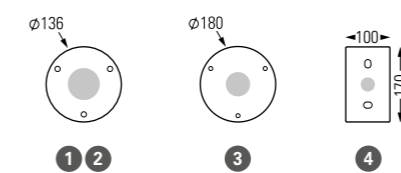



# Commitment against light pollution

Roger Pradier® is committed to complying with the new regulations against light pollution. In France in particular, the Decree of 27 December 2018 on the prevention, reduction and limitation of light pollution regulates lighting practices. Since 1 January 2020, these provisions apply to «light installations» in order to be consistent with today's environmental issues.



Colour temperature  $\leq 3000\text{K}$   
ULOR  $< 1\%$

## Compliance with PRM standards (Person with Reduced Mobility)

Any external path must be structured in such a way as to allow any user, and in particular persons with reduced mobility (PRM), access to the entrance of an establishment open to the public. For this path to be accessible, taking into account the transition zones, its horizontal mean illumination level (Eav) to be maintained at ground level over its entire length must respect 20 lux average (according to the legislation of each country).

Many Roger Pradier® luminaires make it possible to meet PRM requirements. They can be identified in the pages of this catalogue by the presence of a PRM table. Some collections, such as Tetra and Hector, offer special performance thanks to the Asymmetrical LED technology that allows spacing of up to 12 m for bollards and 25 m for poles, while respecting the Eav = 20 lux.

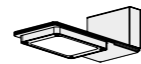

Hector Asymmetric p.42

PRM Eav 20 lux

LED ASYM 35W	Pathway	Spacing
H 3,00 m	3,00 m	25,00 m

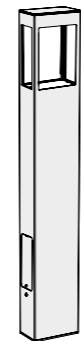

Tetra Asymmetric p.48

PRM Eav 20 lux

LED ASYM 12W	Pathway	Spacing
H 1,10 m	2,00 m	12,00 m

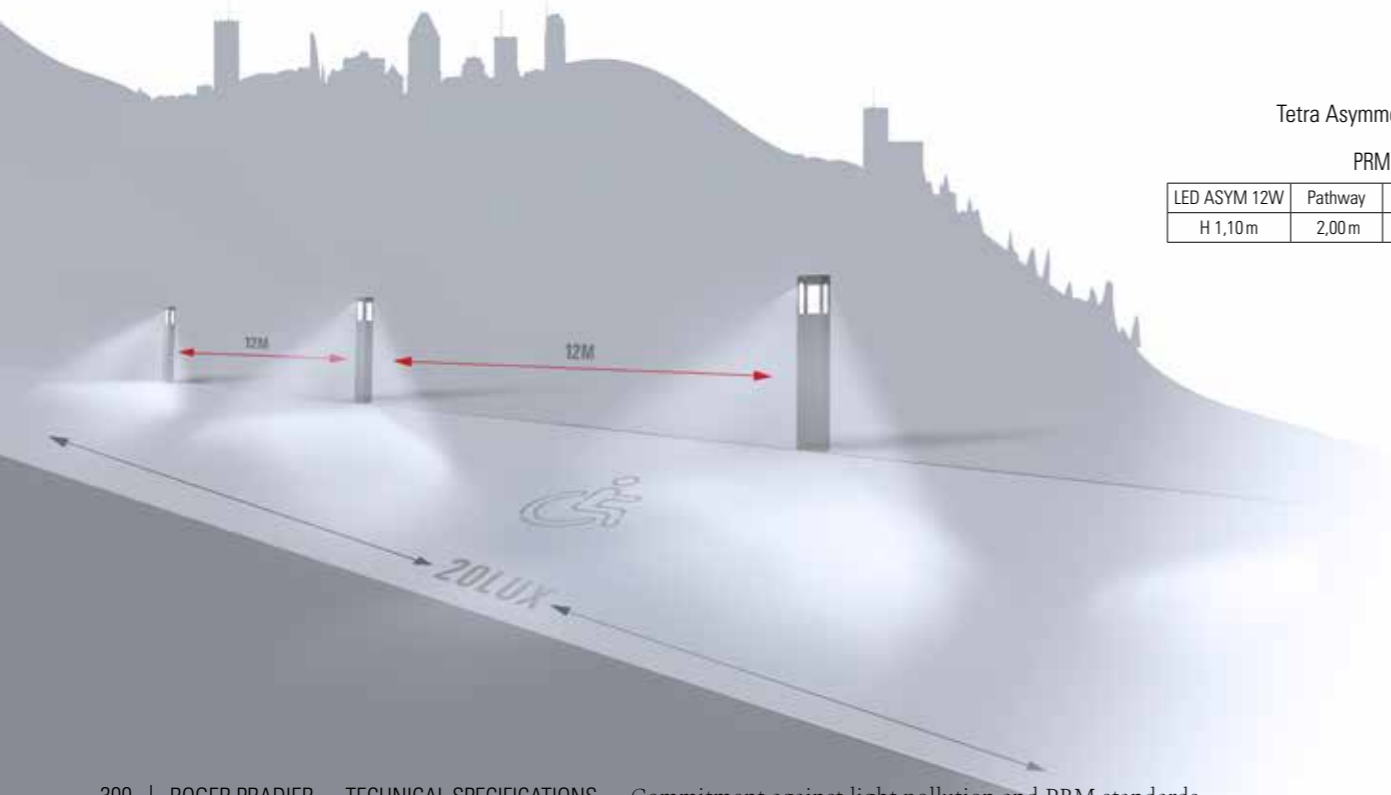



# Accessories

## IP68 waterproof connector

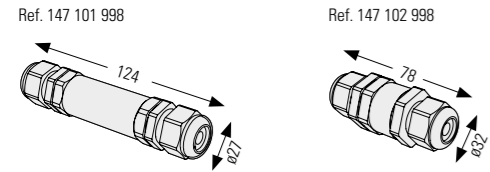

## IP68 waterproof connector (1-in 2-out)

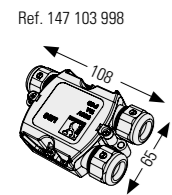

## Frosted PMMA Bulb cover

Exclusively for the Tetra collection.

Ref. 165 075 606

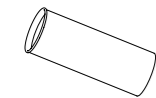

## Light bulbs

Ref. 147 014 998  
E27 LED 12V-24V AC/DC  
6W 2700°K (690lm)

Ref. 147 012 998  
G9 LED 230V  
4,8W 2700°K (600lm)

Ref. 147 013 998  
R7s LED 230V  
6W 2700°K (800lm)

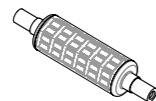
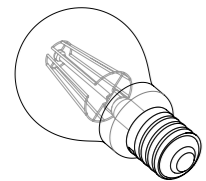

Exclusively for Class 3 models in the Tetra, Brick<sup>2</sup>, RP195 and Sherlock collections.

For the Plémo, Ronex Louis Philippe 2 and Louis Philippe 7 models.

For models of the Carex collection.

## Anchor bolts on request

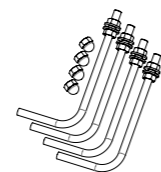

Ref. 147 108 998

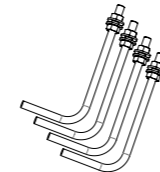

Ref. 147 109 998

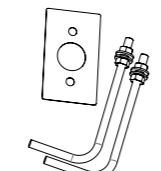

Ref. 147 110 998

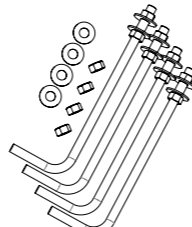

Ref. 147 111 998

COLLECTIONS	N° MODELS	REFERENCES
HECTOR	2	147 108 998
	3	147 111 998
TETRA	5	147 110 998
OL33	6, 7	147 108 998
AVENUE 2	11	147 109 998
AVENUE 3	7, 8, 9	147 109 998
	11	147 108 998
AVENUE 4	6	147 110 998
	8, 9	147 111 998
LOUIS XIII	6, 7	147 109 998
CITADELLE	4	147 110 998
	5, 7	147 111 998
LOUVRE	10, 11	147 109 998
PLACE DES VOSGES 2	11	147 109 998
PLACE DES VOSGES 3	7, 8, 10	147 109 998
LAMPIOK 2	4, 5	147 108 998
LAMPIOK 4	3, 4, 5, 6	147 111 998

## Globes

MODELS	OPAL PMMA GLOBES	SMOKED PMMA GLOBE
 Diameter 200 mm Ø Int. : 76 mm Ø Ext. : 82 mm With thread 60W max.	165 015 606	165 015 607
	 Diameter 300 mm Ø Int. : 112 mm Ø Ext. : 139 mm With bayonet system 100W max.	165 016 606

# Accessories

## Corner plates

### MODELS

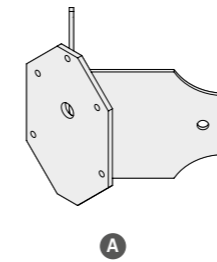

A

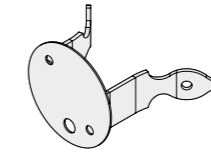

B

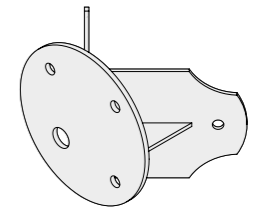

C

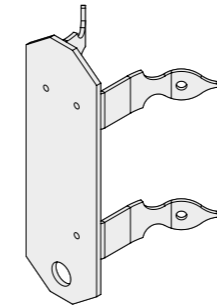

D

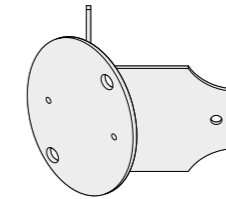

E

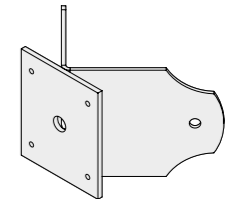

F

### REFERENCES

Replace ●●● with the colour code

MODELS

A	B	C	D	E	F
147 001 ●●●	147 002 ●●●	147 003 ●●●	147 004 ●●●	147 005 ●●●	147 006 ●●●

### COLOUR CODES

Replace ●●● with the colour code



	RAL 9005 JET BLACK 000		RAL 5009 MATTE AZURE BLUE 134
	SLATE GREY 059		BLUE 111
	DARK GREY 006		WHITE 001
	OLD RUSTIC 046		RAL 3005 WINE RED 066
	SANDSTONE 054		RAL 6009 BRITISH GREEN 019
	LIMESTONE 053		RAL 6025 FERN GREEN 109
	METAL GREY 023		GREEN PATINA 008
	RAL 7044 SILK GREY 105		GOLD PATINA 009
	RAL 5011 STEEL BLUE 065	Other colours on request	







# Ingress Protection (IP) ratings

The degrees of protection (IP) are defined by the french standard NF EN 60-529

IP **X**\_ : protection rating against solids

- IP **0**\_ : No protection
- IP **1**\_ : Protected against solid foreign objects over 50 mm in diameter (e.g. involuntary contact with the hand)
- IP **2**\_ : Protected against solid foreign objects over 12 mm in diameter (e.g. finger)
- IP **3**\_ : Protected against solid foreign objects over 2,5 mm in diameter (e.g. tools and wires)
- IP **4**\_ : Protected against solid foreign objects over 1 mm in diameter (e.g. small tools and wires)
- IP **5**\_ :  Dust-protected (no harmful deposits)
- IP **6**\_ :  Totally protected against dust

IP **\_X** : protection rating against liquids

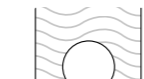
- IP **\_0** : No protection
- IP **\_1** : Protected against vertically dripping water (e.g. condensation)
- IP **\_2** : Protected against dripping water up to 15° from vertical
- IP **\_3** : Protected against direct spray of water up to 60° from vertical
- IP **\_4** :  Protected against direct spray of water from all directions
- IP **\_5** :  Protected against jet of water from all directions applied by spray lance
- IP **\_6** :  Protected against direct sprays of water comparable to big waves
- IP **\_7** :  Protected against the effects of immersion
- IP **\_8** :  Protected against long periods of immersion under pressure

# Glossary

«Boomerang»: wall mounting plate

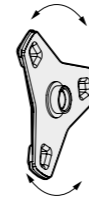

Can be easily and quickly mounted to any surface.  
Allows pre-installation.  
Isolates the Aluminium casing from the wall.  
Wall light can easily be rotated and locked in place.

«Easycap»: waterproof quick-connect system



«Easycap» is a patented membrane that allows wires to be directly connected.

Solid-core wires can be directly pushed through the membrane.  
For stranded wires, the installer must crimp cable terminals first.

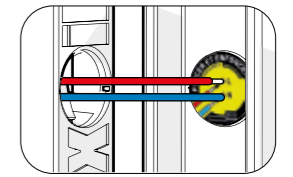

# Information

Each reference is a complete product.

Light bulbs are not included.

All standard Roger Pradier®'s electrical plugs are Schuko type F (mobile models).

Models in brass or copper are provided with black Aluminium supports.

The steel supports are not covered by the anti-corrosion warranty.

The coating of brass, copper, zinc, stainless steel, or enamelled steel models can deteriorate depending on the climate or the environment. These materials are not guaranteed against oxidation.

It is recommended to regularly maintain the light fixtures in accordance with the practices of the profession and to prohibit the use of any abrasive or corrosive material or product.

Our terms of sale are listed on the back of our delivery notes and bills.

As part of its constant strive to improve the quality of the light fixtures, Roger Pradier® reserves the right to modify, without notice or compensation, all or part of the equipment presented in this catalogue.

The images, dimensions and scenarios in the photographs in this catalogue cannot be regarded as contractual.



# Acknowledgements

Our warmest thanks to all those who allowed us to photograph our luminaires by opening their doors to us:

- Anne de Varennes, Abbaye de Varennes (36)
- Monsieur et Madame Vincent Breugelmanns
- Jean-Marc de Pas, Le Jardin des Sculptures, Château de Bois-Guilbert (76)
- La ville de Châteauroux (36)
- Le Centre National de Tir Sportif, Déols (36)
- Le Cercle Nautique du Cap-Ferret (33)
- Chez Boulan, Lège-Cap-Ferret (33)
- Monsieur et Madame Lucien Giraud
- Monsieur et Madame Pierre-François Grandjean
- Monsieur et Madame Grob
- L'Hôtel 202, Hossegor (40)
- L'Hôtel Berría, Hasparren (64)
- L'Hôtel La Roya, Saint-Florent (20)
- L'Hôtel du Palais, Biarritz (64)
- La Cabane Blanche, Cap Ferret (33)
- Les Jardins de Poulaines (36)
- Le Rize - Centre Mémoires et Société, Villeurbanne (69)
- Monsieur Jean-François Piaulet
- Monsieur Jean-Luc Tamanti, Carrière Sarragan (13)
- Monsieur et Madame Simon Verspreuwen

Many thanks also to all those who have worked to produce this catalog.

## Photo credits

- © Arnaud Childéric - Kalice photographies
- © Image de Marc
- © Camillegabarra
- © Grabuge.co

## Graphic design and production

- Roger Pradier®
- Team drawings: Stéphane Joyeux

Legal deposit: Novembre 2023  
Printed in France by Centr'Imprim in Issoudun (36)



Colours and finishes shown in this catalogue are merely indicative due to printing processes. Please refer to our real colourswatches for a more realistic rendering.

## Colours

- VELVET BLACK 113
- RAL 9005 JET BLACK 000
- RAL 7021 BLACK GREY 107
- SLATE GREY 059
- DARK GREY 006
- OLD RUSTIC 046
- SANDSTONE 054
- LIMESTONE 053
- METAL GREY 023
- RAL 7044 SILK GREY 105
- RAL 5011 STEEL BLUE 065
- RAL 5009 MATTE AZURE BLUE 134
- BLUE 111
- WHITE 001
- RAL 9010 PURE WHITE 101
- RAL 9016\* TRAFFIC WHITE 114
- RAL 3005 WINE RED 066
- RAL 3013 TOMATO RED 110
- RAL 3020 TRAFFIC RED 056
- RAL 2004 PURE ORANGE 014
- RAL 1016\* SULFUR YELLOW BRILLANT 057
- RAL 1016 GLOSSY SULFUR YELLOW 068
- RAL 6009 BRITISH GREEN 019
- RAL 6009 FIR GREEN 067
- RAL 6025 FERN GREEN 109
- RAL 6018 YELLOW GREEN 015
- RAL 6021 PALE GREEN 133

## Patinas

- GREEN PATINA 008
- GOLD PATINA 009

## Materials

- LACQUERED PATINATED COPPER 080
- TINTED LACQUERED BRASS 070
- RAW COPPER 082
- RAW BRASS 072
- STAINLESS STEEL 018
- RAW ZINC 092
- \*\*RAW ALUMINIUM - MATTE VARNISH 129
- \* WHITE ENAMELLED STEEL 131
- \* BLACK ENAMELLED STEEL 132
- \*\* BLACK ANODIZED 144

\*Only for Cooper / \*\* Only for Brick² model 1

25 Year warranty anti-corrosion on aluminium





Pale green 133

Distribution and Assistance in Switzerland

**Leman Telecommunication**

Chemin des Épinglis 21  
CH 1257 Bardonnex GE  
www.lemantel.ch  
info@lemantel.ch

**ROGER PRADIER**

France +33(0)2 54 53 56 54  
International +33(0)2 54 53 56 56  
Fax +33(0)2 54 34 78 45  
info@roger-pradier.com  
roger-pradier.com

*Factory – Headquarters*

46 avenue d'Occitanie  
36250 Saint-Maur - France

*Trade office Paris*

12 rue Lamartine  
75009 Paris - France

